

# Operator's Manual

14221-1100-2010

*Rev. J, August 2017*



## XG-75P Series Portable Radios



**L3HARRIS™**  
FAST. FORWARD.

REV	DATE	REASON FOR REVISION
-	Sep/11	Initial release.
A	Nov/11	Updated Table 1-2.
B	Jul/12	Added OpenSky operation.
C	May/13	Added stealth mode and PIN entry (ECP R16A), Audio Playback. Included OTP R20A features. Updates to OpenSky operation. Updated options and accessories table. Updated warranty.
D	Sep/13	Updated options and accessories table. Updated cleaning procedure.
E	Oct/14	Added Radio TextLink, View GPS, Control and Status Services, CE information, and Voice Annunciation. Updated options and accessories and data TX/RX indication.
F	Sep/15	Updated for XGP R5A. Added HAZLOC info.
G	May/16	Added UL info.
H	Jan/17	Added Sections 9.34 and 10.38.
J	Aug/17	Removed CE info.

**CREDITS**

Harris, OpenSky, and EDACS are registered trademarks and TECHNOLOGY TO CONNECT, INFORM AND PROTECT, ProScan, and Failsoft are trademarks of L3Harris Technologies.

RBRC and 1-800-8-BATTERY are registered trademarks of Rechargeable Battery Recycling Corporation.

AMBE is a registered trademark and IMBE, AMBE+, and AMBE+2 are trademarks of Digital Voice Systems, Inc.

All other product and brand names are trademarks, registered trademarks, or service marks of their respective holders.

**NOTICE!**

The material contained herein is subject to U.S. export approval. No export or re-export is permitted without written approval from the U.S. Government. Rated: EAR99; in accordance with U.S. Dept. of Commerce regulations 15CFR774, Export Administration Regulations.

Information and descriptions contained herein are the property of L3Harris Technologies. Such information and descriptions may not be copied or reproduced by any means, or disseminated or distributed without the express prior written permission of L3Harris Technologies, PSPC Business, 221 Jefferson Ridge Parkway, Lynchburg, VA 24501.



This product conforms to the European Union WEEE Directive 2012/19/EU. Do not dispose of this product in a public landfill. Take it to a recycling center at the end of its life.



L3Harris products comply with the Restriction of the Use of Certain Hazardous Substances in Electrical and Electronic Equipment (RoHS) Directive.

The voice coding technology embodied in this product is protected by intellectual property rights including patent rights, copyrights, and trade secrets of Digital Voice Systems, Inc. The user of this technology is explicitly prohibited from attempting to decompile, reverse engineer, or disassemble the Object Code, or in any other way convert the Object Code into human-readable form.

Repairs to this equipment should be made only by an authorized service technician or facility designated by the supplier. Any repairs, alterations, or substitution of recommended parts made by the user to this equipment not approved by the manufacturer could void the user's authority to operate the equipment in addition to the manufacturer's warranty.

This manual is published by **L3Harris Technologies** without any warranty. Improvements and changes to this manual necessitated by typographical errors, inaccuracies of current information, or improvements to programs and/or equipment, may be made by **L3Harris Technologies** at any time and without notice. Such changes will be incorporated into new editions of this manual. No part of this manual may be reproduced or transmitted in any form or by any means, electronic or mechanical, including photocopying and recording, for any purpose, without the express written permission of **L3Harris Technologies**.

## TABLE OF CONTENTS

	<i>Page</i>
<b>1. REGULATORY AND SAFETY INFORMATION .....</b>	<b>9</b>
1.1 SAFETY CONVENTIONS.....	9
1.2 SAFETY TRAINING INFORMATION.....	9
1.2.1 RF Exposure Guidelines .....	10
1.2.2 Electromagnetic Interference/Compatibility.....	11
1.2.3 Radio Frequency Interference.....	11
1.3 OPERATING TIPS.....	12
1.3.1 Efficient Radio Operation .....	12
1.3.2 Antenna Care and Replacement.....	12
1.3.3 Electronic Devices.....	12
1.3.4 Aircraft.....	13
1.3.5 Electric Blasting Caps .....	13
1.3.6 Potentially Explosive Atmospheres .....	13
<b>2. RENSEIGNEMENTS SUR LA RÉGLEMENTATION ET SÉCURITÉ .....</b>	<b>14</b>
2.1 CONVENTIONS SUR LES SYMBOLES DE SÉCURITÉ .....	14
2.2 RENSEIGNEMENTS SUR LA FORMATION SUR LA SÉCURITÉ .....	14
2.2.1 Directives sur l'exposition aux RF .....	15
2.2.2 Interférence/Compatibilité Électromagnétique .....	16
2.3 INTERFÉRENCE DES RADIOFRÉQUENCES .....	16
2.3.1 Partie 15 de la FCC.....	16
2.3.2 Industrie Canada.....	16
2.4 CONSEILS D'UTILISATION .....	16
2.4.1 Utilisation Efficace de la Radio.....	17
<b>3. HAZARDOUS LOCATIONS.....</b>	<b>19</b>
<b>4. CLEANING .....</b>	<b>21</b>
<b>5. BATTERIES .....</b>	<b>22</b>
5.1 CONDITIONING BATTERY PACKS.....	22
5.1.1 Conditioning NiMH Battery Packs .....	22
5.1.2 Conditioning Li-Ion or Li-Poly packs.....	22
5.2 STORING LI-ION BATTERY PACKS .....	22
5.3 CHARGING BATTERY PACKS.....	23
5.4 BATTERY PACK USAGE .....	23
5.5 ADDITIONAL INFORMATION .....	23
5.6 CHANGING THE BATTERY PACK.....	24
5.6.1 Removing the Battery Pack.....	24
5.6.2 Attaching the Battery Pack.....	25
5.7 BATTERY DISPOSAL .....	25
<b>6. INTRODUCTION .....</b>	<b>26</b>
<b>7. OPTIONS AND ACCESSORIES.....</b>	<b>27</b>
<b>8. CHANGE OPERATING MODE .....</b>	<b>29</b>
8.1 CHANGE FROM OTP MODE .....	29
8.2 CHANGE TO OTP MODE .....	29
<b>9. OPENSKY OPERATION.....</b>	<b>30</b>
9.1 CONTROLS.....	30

## TABLE OF CONTENTS

	<u>Page</u>
9.1.1 Buttons, Knobs, and Switch .....	31
9.1.2 Keypad.....	32
9.1.3 Display .....	33
9.1.4 Radio Status Icons.....	33
9.2 TRI-COLOR LED .....	34
9.3 LOG-IN TO THE NETWORK.....	34
9.4 LOG OFF THE NETWORK .....	35
9.5 PERSONALITY .....	35
9.5.1 Profiles.....	35
9.5.2 Talk Groups .....	36
9.6 OPENSKY DISPLAY OVERVIEW.....	36
9.6.1 Display's Top Line.....	36
9.6.2 Display's Second Line .....	36
9.6.3 Dwell Display .....	36
9.7 ALERT TONES.....	36
9.8 BASIC MENU STRUCTURE .....	38
9.9 ERROR MESSAGES .....	40
9.10 KEYPAD FUNCTION COMMANDS (SYSTEM MODEL ONLY) .....	42
9.11 QUICK KEYS (SYSTEM MODEL ONLY).....	43
9.12 DTMF OVERDIAL .....	43
9.13 LOCK/UNLOCK THE KEYPAD .....	44
9.14 DUAL-TONE MULTI-FREQUENCY (SYSTEM MODEL ONLY).....	44
9.15 CHANGING THE ACTIVE PROFILE.....	44
9.16 CHANGING THE SELECTED TALK GROUP .....	44
9.17 ADJUSTING DISPLAY AND BUTTON BACKLIGHT BRIGHTNESS .....	44
9.18 STEALTH MODE.....	44
9.18.1 Enabling Stealth Mode.....	44
9.18.2 Disabling Stealth Mode .....	45
9.19 ADJUSTING SIDE TONE AUDIO LEVEL .....	45
9.20 CHANGE OPERATING MODE .....	45
9.20.1 From OTP to ECP Mode.....	45
9.20.2 From ECP to OTP Mode.....	46
9.21 RECEIVING AND TRANSMITTING VOICE CALLS.....	46
9.21.1 Receiving a Voice Call .....	46
9.21.2 Transmitting a Voice Call .....	46
9.22 ADJUSTING AUDIO TREBLE LEVEL.....	47
9.23 TALK GROUP LOCK OUT .....	47
9.23.1 Lock Out a Talk Group.....	47
9.23.2 Unlock a Talk Group .....	48
9.24 SCANNING.....	48
9.24.1 Selecting Scan Modes .....	48
9.24.2 Changing Active Scan Mode .....	49
9.24.3 Scanning Priority.....	49
9.24.4 Scan Mode A/B Switch .....	50
9.24.5 Scan Mode Quick Key (System Model Only).....	50
9.25 MAKING SELECTIVE CALLS .....	50
9.25.1 Manually Dialing a Selective Call (System Model Only) .....	51
9.25.2 Selective Call Using Speed Dial .....	51

## TABLE OF CONTENTS

	<i>Page</i>
9.25.3 Accepting a Selective Call.....	52
9.25.4 Rejecting a Selective Call .....	52
9.25.5 Terminating a Selective Call .....	52
9.26 SELECTIVE ALERTS .....	52
9.26.1 Defining Messages.....	52
9.26.2 Sending a Message .....	53
9.26.3 Receiving a Message.....	54
9.26.4 Deleting a Selective Alert Message .....	54
9.27 MAKING INTERCONNECT CALLS (SYSTEM MODEL ONLY) .....	54
9.28 EMERGENCY COMMUNICATIONS .....	55
9.28.1 Declaring an Emergency Call or Alert .....	55
9.28.2 Receiving an Emergency Call.....	56
9.28.3 Dismissing an Emergency.....	56
9.28.4 Clearing an Emergency Call or Alert.....	56
9.29 OPENSKEY ENCRYPTION .....	57
9.29.1 Automatic Encryption .....	57
9.29.2 A/B Switch.....	57
9.29.3 Manual Encryption (System Model Only) .....	57
9.30 STATUS MESSAGES.....	58
9.30.1 Send Status Message via the Keypad (System Model Radios Only) .....	58
9.30.2 Send Status Message via the Menu .....	59
9.31 REQUEST TO TALK (RTT) MESSAGES .....	59
9.31.1 Send RTT Message via the Keypad (System Model Radios Only).....	59
9.31.2 Send RTT Message via the Menu.....	59
9.32 SITE LOCK.....	59
9.33 GPS COORDINATES.....	60
9.34 USING THE GPS SPEAKER MIC .....	60
9.35 V-TAC OPERATION .....	60
9.35.1 Extended Coverage Modes (XCOV, XCOV-TG, and XCOV-PROF) .....	60
9.35.2 Change Between Extended Coverage Modes .....	61
9.35.3 Radio Limitations Using Extended Coverage Modes.....	61
9.35.4 Use XCOV Mode.....	62
9.35.5 Use XCOV-TG Mode .....	62
9.35.6 Using XCOV-PROF Mode.....	63
9.35.7 Use Scene-of-Incident Mode.....	64
<b>10. EDACS, CONVENTIONAL, AND P25 OPERATION.....</b>	<b>66</b>
10.1 TURNING ON THE RADIO.....	66
10.2 CONTROLS.....	67
10.2.1 Buttons, Knobs, and Switch .....	68
10.2.2 Keypad.....	69
10.3 DISPLAY.....	70
10.4 TRI-COLOR LED .....	71
10.5 UNIVERSAL DEVICE CONNECTOR.....	72
10.6 NOISE CANCELLATION .....	72
10.6.1 Turning Noise Cancellation On and Off .....	72
10.6.2 Using Noise Cancellation .....	73
10.6.3 The Effect of Distance from the Microphone.....	73
10.6.4 Primary versus Secondary Microphone .....	73

## TABLE OF CONTENTS

	<u>Page</u>
10.7 STATUS MESSAGES (EDACS AND P25 TRUNKED) .....	74
10.8 ERROR MESSAGES .....	74
10.9 ALERT TONES.....	75
10.10 VOICE ANNUNCIATION .....	75
10.11 SYSTEM/ZONE SELECTION .....	75
10.12 GROUP/CHANNEL SELECTION.....	76
10.13 MODIFY SCAN LIST .....	77
10.13.1 System Model Radio .....	77
10.13.2 Scan Model Radio.....	77
10.14 MENU .....	77
10.14.1 Menu Item Selection Process .....	78
10.15 BACKLIGHT ADJUST .....	80
10.16 CONTRAST ADJUST .....	80
10.17 DECLARE AN EMERGENCY .....	80
10.18 LOCKING/UNLOCKING KEYPAD.....	81
10.19 HIGH/LOW POWER ADJUSTMENT.....	81
10.20 ENCRYPTION .....	81
10.20.1 Displaying the Currently Used Cryptographic Key Number .....	81
10.20.2 Key Zero .....	82
10.20.3 Receiving an Encrypted Call.....	82
10.20.4 Transmitting an Encrypted Call.....	82
10.20.5 Emergencies on Encrypted Group.....	82
10.21 SCANNING TRUNKED GROUPS.....	83
10.21.1 Turning Scan On and Off .....	83
10.21.2 Adding Groups to a Scan List .....	83
10.21.3 Deleting Groups from a Scan List.....	84
10.21.4 Nuisance Delete.....	85
10.21.5 Mixed Zone Scan .....	85
10.22 SCANNING TRUNKED SYSTEMS .....	86
10.22.1 Wide Area System Scanning .....	87
10.22.2 Priority System Scan.....	87
10.22.3 ProScan .....	87
10.23 EMERGENCY OPERATION .....	88
10.23.1 Receiving an Emergency Call.....	88
10.23.2 Declaring an Emergency Call.....	88
10.24 MIXED SYSTEM ZONES .....	89
10.25 CALLER ID .....	89
10.26 STEALTH MODE .....	89
10.27 INDIVIDUAL CALLS .....	90
10.27.1 Receiving and Responding to an Individual Call.....	90
10.27.2 Sending an Individual Call .....	91
10.27.3 Call Storage Lists.....	91
10.28 TELEPHONE INTERCONNECT CALLS.....	92
10.28.1 Receiving a Telephone Interconnect Call .....	92
10.28.2 Sending a Telephone Interconnect Call.....	92
10.28.3 Dual-Tone Multi-Frequency: Overdial .....	93
10.29 PRE-STORING INDIVIDUAL AND TELEPHONE INTERCONNECT CALLS FROM THE KEYPAD .....	94

## TABLE OF CONTENTS

	<i>Page</i>
10.30 STATUS/MESSAGE OPERATION .....	95
10.30.1 Status Operation .....	95
10.30.2 Message Operation .....	95
10.31 DYNAMIC REGROUP OPERATION (EDACS) .....	96
10.32 MACRO KEY OPERATION .....	96
10.33 DATA COMMUNICATIONS .....	96
10.33.1 Displays .....	97
10.33.2 Data Off Operation .....	97
10.33.3 Data On Operation .....	97
10.33.4 Exiting Data Calls .....	97
10.33.5 Scan Lockout Mode .....	97
10.33.6 Data Lockout Mode .....	98
10.34 SELECTIVE SIGNALING (CONVENTIONAL) .....	98
10.34.1 Type 99 Operation .....	98
10.34.2 Type 99 with or without Channel Guard .....	98
10.34.3 Resetting Type 99 after a Call .....	99
10.34.4 Type 99 Disable after PTT .....	99
10.35 AUDIO PLAYBACK .....	99
10.36 RADIO TEXTLINK OPERATION .....	99
10.36.1 Send TextLink Messages .....	99
10.36.2 View Received TextLink Messages .....	99
10.36.3 Delete TextLink Messages .....	100
10.36.4 View the Current Time .....	100
10.37 VIEW GPS INFORMATION .....	100
10.38 USING THE GPS SPEAKER MIC .....	100
10.39 CONTROL AND STATUS SERVICES .....	101
<b>11. PREVENTIVE MAINTENANCE .....</b>	<b>102</b>
11.1 IMMERSIBLE PREVENTIVE MAINTENANCE .....	102
11.2 BASIC TROUBLESHOOTING .....	103
<b>12. CUSTOMER SERVICE .....</b>	<b>104</b>
12.1 CUSTOMER CARE .....	104
12.2 TECHNICAL ASSISTANCE .....	104
<b>13. WARRANTY .....</b>	<b>105</b>

## FIGURES

Figure 5-1: Removing the Battery Pack .....	24
Figure 5-2: Attaching the Battery Pack .....	25
Figure 9-1: Top View .....	30
Figure 9-2: Side View .....	30
Figure 9-3: Scan Model Front Panel .....	32
Figure 9-4: System Model Front Panel .....	32
Figure 9-5: Radio Display OpenSky Mode .....	33
Figure 9-6: Tri-Color LED .....	34
Figure 9-7: Personality Structure Example .....	35
Figure 10-1: Top View .....	67
Figure 10-2: Side View .....	67
Figure 10-3: Scan Model Front Panel .....	69
Figure 10-4: System Model Front Panel .....	69

**TABLE OF CONTENTS**

	<u>Page</u>
Figure 10-5: XG-75P Radio Display.....	70
Figure 10-6: Tri-Color LED.....	71
Figure 10-7: XG-75P 15-Pin Universal Device Connector.....	72
Figure 10-8: Using the Noise Cancellation Feature.....	73
Figure 10-9: Menu Display.....	77
Figure 10-10: Backlight Menu Item Selection Parameter.....	78
Figure 10-11: Backlight Menu Display.....	78
Figure 10-12: System Encryption Key Display.....	81
Figure 10-13: Group/Channel Encryption Key Display.....	82
Figure 10-14: Calls Received Lists.....	90
Figure 10-15: WHC Individual Call Display.....	90
Figure 10-16: Calls Received and Personality Lists.....	92
Figure 11-1: Labels.....	102

**TABLES**

Table 1-1: RF Exposure Compliance Testing Distances.....	11
Table 1-2: Distance from Body for Different Carrying Options.....	11
Tableau 2-1: Distances de test de conformité des expositions aux RF.....	15
Tableau 2-2: Distance du corps pour différentes options de transport.....	15
Table 7-1: Options and Accessories.....	27
Table 9-1: Buttons, Knobs, and Switch Functions.....	31
Table 9-2: Keypad Functions.....	32
Table 9-3: Status Icons Descriptions.....	33
Table 9-4: Alert Tones.....	36
Table 9-5: Basic OpenSky Menu Structure.....	38
Table 9-6: Keypad Function Commands.....	42
Table 9-7: Quick Key Sequence.....	43
Table 9-8: Scan Modes.....	48
Table 9-9: Status of Selective Call.....	51
Table 9-10: Status of Selective Alert Messages.....	53
Table 9-11: Emergency Calls vs. Emergency Alerts.....	55
Table 9-12: Band Definitions.....	65
Table 10-1: Buttons, Knobs, and Switch Functions.....	68
Table 10-2: XG-75P Front Keypad Functions.....	69
Table 10-3: Status Icons Descriptions.....	70
Table 10-4: Alert Tones.....	75
Table 10-5: Menu Item Information.....	79
Table 10-6: Information Display.....	80
Table 11-1: Troubleshooting.....	103

L3Harris Technologies, Public Safety and Professional Communications (PSPC) Business continually evaluates its technical publications for completeness, technical accuracy, and organization. You can assist in this process by submitting your comments and suggestions to the following:

**L3Harris Technologies, Inc.**  
 PSPC Business  
 Technical Publications  
 221 Jefferson Ridge Parkway  
 Lynchburg, VA 24501

fax your comments to: 1-434-455-6851  
 or  
 e-mail us at: [PSPC\\_techpubs@l3harris.com](mailto:PSPC_techpubs@l3harris.com)



# 1. REGULATORY AND SAFETY INFORMATION

## 1.1 SAFETY CONVENTIONS

The following conventions are used throughout this manual to alert the user to general safety precautions that must be observed during all phases of operation, service, and repair of this product. Failure to comply with these precautions or with specific warning elsewhere in this manual violates safety standards of design, manufacture, and intended use of the product. L3Harris assumes no liability for the customer's failure to comply with these standards.



The **WARNING** symbol calls attention to a procedure, practice, or the like, which, if not correctly performed or adhered to, could result in personal injury. Do not proceed beyond a **WARNING** symbol until the conditions identified are fully understood or met.



The **CAUTION** symbol calls attention to an operating procedure, practice, or the like, which, if not performed correctly or adhered to, could result in damage to the equipment or severely degrade the equipment performance.



The **NOTE** symbol calls attention to supplemental information, which may improve system performance or clarify a process or procedure.

## 1.2 SAFETY TRAINING INFORMATION



The L3Harris XG-75P portable radio generates RF electromagnetic energy during transmit mode. This radio is designed for and classified as “Occupational Use Only,” meaning it must be used only during the course of employment by individuals aware of the hazards and the ways to minimize such hazards. This radio is **NOT** intended for use by the “General Population” in an uncontrolled environment.

The XG-75P portable radio has been tested and complies with the FCC RF exposure limits for “Occupational Use Only.” In addition, this L3Harris radio complies with the following Standards and Guidelines with regard to RF energy and electromagnetic energy levels and evaluation of such levels for exposure to humans:

- FCC OET Bulletin 65 Edition 97-01 Supplement C, Evaluating Compliance with FCC Guidelines for Human Exposure to Radio Frequency Electromagnetic Fields.
- American National Standards Institute (C95.1 – 1992), IEEE Standard for Safety Levels with Respect to Human Exposure to Radio Frequency Electromagnetic Fields, 3 kHz to 300 GHz.

- American National Standards Institute (C95.3 – 1992), IEEE Recommended Practice for the Measurement of Potentially Hazardous Electromagnetic Fields – RF and Microwave.
- DIRECTIVE 2004/40/EC OF THE EUROPEAN PARLIAMENT AND OF THE COUNCIL of 29 April 2004 on the minimum health and safety requirements regarding the exposure of workers to the risks arising from physical agents (electromagnetic fields) and amended by:
- Directive 2007/30/EC of the European Parliament and of the Council of 20 June 2007
- Directive 2008/46/EC of the European Parliament and of the Council of 23 April 2008
- Regulation (EC) No 1137/2008 of the European Parliament and of the Council of 22 October 2008
- Directive 2012/11/EU of the European Parliament and of the Council of 19 April 2012

### 1.2.1 RF Exposure Guidelines



To ensure that exposure to RF electromagnetic energy is within the FCC allowable limits for occupational use and/or the exposure limit values in Annex A of EU Directive 2004/40/EC, always adhere to the following guidelines:

- DO NOT operate the radio without a proper antenna attached, as this may damage the radio and may also cause the FCC RF exposure limits and/or the exposure limit values in Annex A of EU Directive 2004/40/EC to be exceeded. A proper antenna is the antenna supplied with this radio by L3Harris or an antenna specifically authorized by L3Harris for use with this radio. (Refer to Table 7-1.)
- DO NOT transmit for more than 50% of total radio use time (“50% duty cycle”). Transmitting more than 50% of the time can cause FCC RF exposure compliance requirements and/or the exposure limit values in Annex A of EU Directive 2004/40/EC to be exceeded. The radio is transmitting when the “TX” indicator appears in the display. The radio will transmit by pressing the “PTT” (Push-To-Talk) button.
- ALWAYS transmit using low power when possible. In addition to conserving battery charge, low power can reduce RF exposure.
- ALWAYS use L3Harris authorized accessories (antennas, batteries, belt clips, speaker/mics, etc.). Use of unauthorized accessories may cause the FCC Occupational/Controlled Exposure RF compliance requirements and/or the exposure limit values in Annex A of EU Directive 2004/40/EC to be exceeded. (Refer to Table 1-1.)
- As noted in Table 1-1, ALWAYS keep the housing of the transmitter **AT LEAST** 1.6 cm (0.63 inches) from the body and at least 2.5 cm (1.0 inch) from the face when transmitting to ensure FCC RF exposure compliance requirements and/or the exposure limit values in Annex A of EU Directive 2004/40/EC are not exceeded. However, to provide the best sound quality to the recipients of your transmission, L3Harris recommends you hold the microphone at least 5 cm (2 inches) from mouth, and slightly off to one side.

**Table 1-1: RF Exposure Compliance Testing Distances**

RADIO FREQUENCY	TESTED DISTANCES (worst case scenario)	
	Body	Face
VHF (136 - 174 MHz)	1.6 cm	2.5 cm
UHF-L (378 - 470 MHz)	1.6 cm	2.5 cm
700-800 MHz	1.6 cm	2.5 cm

**Table 1-2: Distance from Body for Different Carrying Options**

CARRYING CONFIGURATION	TESTED DISTANCES (worst case from body)
Belt Clip	1.8 cm
Leather Case with Belt Loop	5.2 cm
Nylon Case with Belt Loop	4.5 cm
Shoulder Strap with D-clip	3.0 cm
Speaker-microphone with antenna	1.6 cm

The information in this section provides the information needed to make the user aware of RF exposure, and what to do to assure that this radio operates within the FCC RF exposure and/or the exposure limit values in Annex A of EU Directive 2004/40/EC limits.

### **1.2.2 Electromagnetic Interference/Compatibility**

During transmissions, this L3Harris radio generates RF energy that can possibly cause interference with other devices or systems. To avoid such interference, turn off the radio in areas where signs are posted to do so. DO NOT operate the transmitter in areas that are sensitive to electromagnetic radiation such as hospitals, aircraft, and blasting sites.

### **1.2.3 Radio Frequency Interference**

#### **1.2.3.1 Part 15**

This device complies with Part 15 of the FCC Rules. Operation is subject to the following two conditions:

1. This device may not cause harmful interference, and
2. This device must accept any interference received, including interference that may cause undesired operation.

#### **1.2.3.2 Industry Canada**

This device complies with Industry Canada license-exempt RSS standard(s). Operation is subject to the following two conditions: (1) this device may not cause interference, and (2) this device must accept any interference, including interference that may cause undesired operation of the device.

## 1.3 OPERATING TIPS

Antenna location and condition are important when operating a portable radio. Operating the radio in low lying areas or terrain, under power lines or bridges, inside of a vehicle or in a metal framed building can severely reduce the range of the unit. Mountains can also reduce the range of the unit.

In areas where transmission or reception is poor, some improvement may be obtained by ensuring that the antenna is vertical. Moving a few yards in another direction or moving to a higher elevation may also improve communications. Vehicular operation can be aided with the use of an externally mounted antenna.

Battery condition is another important factor in the trouble-free operation of a portable radio. Always properly charge the batteries.

### 1.3.1 Efficient Radio Operation

Keep the antenna in a vertical position when receiving or transmitting a message.

Do not hold the antenna when receiving a message and, especially, do not hold when transmitting a message.



Do **NOT** hold onto the antenna when the radio is powered on!

### 1.3.2 Antenna Care and Replacement



Do **NOT** use the portable radio with a damaged or missing antenna. A minor burn may result if a damaged antenna comes into contact with the skin. Replace a damaged antenna immediately. Operating a portable radio with the antenna missing could cause personal injury, damage the radio, and may violate FCC regulations.



Use only the supplied or approved antenna. Unauthorized antennas, modifications, or attachments could cause damage to the radio unit and may violate FCC regulations. (Refer to Table 7-1.)

### 1.3.3 Electronic Devices



RF energy from portable radios may affect some electronic equipment. Most modern electronic equipment in cars, hospitals, homes, etc. is shielded from RF energy. However, in areas in which you are instructed to turn off two-way radio equipment, always observe the rules. If in doubt, turn it off!

### 1.3.4 Aircraft



- Always turn off a portable radio before boarding any aircraft!
- Use it on the ground only with crew permission.
- **DO NOT** use while in-flight!!

### 1.3.5 Electric Blasting Caps



To prevent accidental detonation of electric blasting caps, **DO NOT** use two-way radios within 1000 feet of blasting operations. Always obey the "Turn Off Two-Way Radios" signs posted where electric blasting caps are being used. (OSHA Standard: 1926.900)

### 1.3.6 Potentially Explosive Atmospheres



Turn OFF radios when in any area with a potentially explosive atmosphere unless the radio is Hazardous Location (HAZLOC) certified.

Areas with potentially explosive atmospheres are often, but not always, clearly marked. These may be fueling areas, such as gas stations, fuel or chemical transfer or storage facilities, and areas where the air contains chemicals or particles, such as grain, dust, or metal powders.



**DO NOT** remove, install, or charge batteries in potentially explosive atmosphere areas.

Sparks in such areas could cause an explosion or fire resulting in bodily injury or even death.

## 2. RENSEIGNEMENTS SUR LA RÉGLEMENTATION ET SÉCURITÉ

### 2.1 CONVENTIONS SUR LES SYMBOLES DE SÉCURITÉ

Les conventions suivantes sont utilisées dans le présent manuel pour avertir l'utilisateur des précautions générales de sécurité qui doivent être observées pendant toutes les phases d'opération, d'entretien et de réparation de ce produit. Le non-respect de ces précautions ou d'avertissements précisés ailleurs enfreint les normes de sécurité de la conception, de la fabrication et de l'utilisation prévue du produit. L3Harris n'assume aucune responsabilité pour le non-respect de ces normes par le client.



Le symbole **MISE EN GARDE** attire l'attention sur une procédure ou une pratique qui, si elle n'est pas correctement effectuée ou observée, pourrait entraîner une blessure personnelle. Ne pas poursuivre au-delà d'un symbole de **MISE EN GARDE** avant que les conditions identifiées soient complètement comprises ou satisfaites.



Le symbole **AVERTISSEMENT** attire l'attention sur une procédure ou une pratique opérationnelle qui, si elle n'est pas correctement effectuée ou observée, pourrait entraîner un bris d'équipement ou une importante baisse de rendement de l'équipement.



Le symbole **REMARQUE** attire l'attention sur des renseignements supplémentaires qui peuvent améliorer le rendement du système ou clarifier un processus ou une procédure.

### 2.2 RENSEIGNEMENTS SUR LA FORMATION SUR LA SÉCURITÉ



La radio portative L3Harris XG-75P produit de l'énergie électromagnétique des RF lorsqu'en mode de transmission. Cette radio est conçue et classée pour une « Utilisation professionnelle seulement », ce qui signifie qu'elle ne doit être utilisée que dans le cadre d'un emploi par des individus conscients des risques et des moyens de limiter ceux-ci. Cette radio **N'EST PAS** conçue pour une utilisation par la « Population générale » dans un environnement non contrôlé.

La radio portative XG-75P a été testée et est conforme aux limites d'exposition aux RF de la FCC pour une « Utilisation professionnelle seulement ». De plus, cette radio L3Harris est conforme aux normes et directives suivantes quant à l'énergie des RF et aux niveaux d'énergie électromagnétique, ainsi qu'à l'évaluation de ces niveaux pour l'exposition aux humains :

- Bulletin 65 du OET de la FCC, édition 97-01, supplément C, portant sur l'évaluation de la conformité aux directives de la FCC quant à l'exposition humaine aux champs électromagnétiques des radiofréquences.

- American National Standards Institute (C95.1 – 1992), norme de l'IEEE sur les niveaux sécuritaires d'exposition humaine aux champs électromagnétiques des radiofréquences, 3 kHz à 300 GHz.
- American National Standards Institute (C95.3 – 1992), pratique recommandée par l'IEEE pour la mesure des champs électromagnétiques potentiellement dangereux – RF et micro-ondes.

### 2.2.1 Directives sur l'exposition aux RF



Pour s'assurer que l'exposition à l'énergie électromagnétique des RF se situe dans les limites acceptables de la FCC pour l'utilisation professionnelle, respectez toujours les directives suivantes :

- N'utilisez PAS la radio sans qu'une antenne appropriée y soit connectée, car ceci peut endommager la radio et également causer un dépassement des limites d'exposition aux RF de la FCC. Une antenne appropriée est celle fournie par L3Harris avec cette radio, ou une antenne spécifiquement autorisée par L3Harris pour être utilisée avec cette radio. (Reportez-vous à Table 7-1.)
- Ne transmettez PAS pendant plus de 50 % de la durée d'utilisation totale de la radio (« cycle de service de 50 % »). La transmission pendant plus de 50 % du temps peut causer un dépassement des exigences de conformité de la FCC en matière d'exposition aux RF. La radio transmet lorsque l'indicateur « TX » apparaît sur l'affichage. La radio transmet lorsqu'on appuie sur le bouton « PTT » (bouton de microphone).
- Transmettez TOUJOURS en basse puissance lorsque possible. En plus de préserver la charge de la pile, une faible puissance réduit l'exposition aux RF.
- Utilisez TOUJOURS des accessoires autorisés L3Harris (antennes, piles, pinces de ceinture, haut-parleurs/micros, etc.). L'utilisation d'accessoires non autorisés peut entraîner un dépassement des exigences de conformité pour une exposition aux RF professionnelle ou contrôlée de la FCC. (Reportez-vous à Tableau 2-1.)
- Tel qu'indiqué dans Tableau 2-1, conservez TOUJOURS l'appareil et son antenne à **AU MOINS** 1,6 cm (0,63 po) du corps, et à au moins 2,5 cm (1,0 po) du visage pendant la transmission, pour vous assurer de ne pas dépasser les exigences de conformité de la FCC en matière d'exposition aux RF. Cependant, pour offrir la meilleure qualité sonore aux auditeurs de votre transmission, L3Harris recommande de tenir le microphone à au moins 5 cm (2 po) de votre bouche et légèrement déplacé sur un côté.

**Tableau 2-1: Distances de test de conformité des expositions aux RF**

RADIOFRÉQUENCES	DISTANCES TESTÉES (pire des scénarios)	
	Corps	Visage
VHF (136 - 174 MHz)	1,6 cm	2,5 cm
UHF-L (378 - 470 MHz)	1,6 cm	2,5 cm
700-800 MHz	1,6 cm	2,5 cm

**Tableau 2-2: Distance du corps pour différentes options de transport**

<b>CONFIGURATION DE TRANSPORT</b>	<b>DISTANCES TESTÉES (DISTANCE MINIMALE AU CORPS)</b>
Attache de ceinture	1,8 cm
Étui en cuir avec ganse de ceinture	5,2 cm
Étui en nylon avec ganse de ceinture	4,5 cm
Bandoulière avec attache en « D »	3,0 cm
Microphone / Haut-parleur avec antenne	1,6 cm

Dans cette section figurent les renseignements nécessaires pour sensibiliser l'utilisateur à l'exposition aux RF et sur ce qu'il faut faire pour s'assurer que cette radio fonctionne dans les limites d'exposition aux RF de la FCC.

### **2.2.2 Interférence/Compatibilité Électromagnétique**

Pendant les transmissions, cette radio L3Harris produit de l'énergie des RF qui peut causer de l'interférence avec d'autres appareils ou systèmes. Pour éviter de telles interférences, fermez la radio dans les zones où il est indiqué de le faire. N'utilisez PAS le transmetteur dans des zones sensibles aux radiations électromagnétiques, comme les hôpitaux, les avions et les sites de détonation.

## **2.3 INTERFÉRENCE DES RADIOFRÉQUENCES**

### **2.3.1 Partie 15 de la FCC**

Cet appareil est conforme à la Partie 15 de la réglementation de la FCC. Le fonctionnement est soumis aux deux conditions suivantes :

1. Cet appareil ne doit pas causer une interférence nuisible; et
2. Cet appareil doit accepter toute interférence reçue, y compris une interférence qui peut causer un fonctionnement non souhaité.

### **2.3.2 Industrie Canada**

Cet appareil est conforme aux normes RSS exemptées de licence d'Industrie Canada. Le fonctionnement est soumis aux deux conditions suivantes : (1) cet appareil ne doit pas causer d'interférence et (2) cet appareil doit accepter toute interférence, y compris une interférence qui peut causer un fonctionnement non souhaité de l'appareil.

## **2.4 CONSEILS D'UTILISATION**

L'emplacement et l'état de l'antenne sont importants pour l'utilisation d'une radio portative. L'utilisation de la radio dans des zones de faible élévation, sous des lignes électriques ou des ponts, à l'intérieur d'un véhicule ou dans un immeuble à ossature métallique, peut réduire la portée de l'appareil de manière considérable. Les montagnes peuvent également réduire la portée de l'unité.

Dans les zones où la transmission ou la réception est insatisfaisante, certaines améliorations peuvent être obtenues en s'assurant que l'antenne est verticale. Se déplacer de quelques mètres dans une autre direction ou à un emplacement plus élevé peut également améliorer les communications. L'utilisation d'une antenne fixée à l'extérieur peut faciliter le fonctionnement dans un véhicule.



L'état de la pile est un autre facteur important d'une utilisation sans tracas d'une radio portative. Chargez toujours correctement la pile.

### 2.4.1 Utilisation Efficace de la Radio

Gardez l'antenne dans une position verticale pendant la réception ou la transmission d'un message.



**Ne tenez PAS l'antenne lorsque la radio est allumée!**

#### 2.4.1.1 Entretien Et Remplacement De L'antenne



**N'utilisez pas la radio portative si son antenne est endommagée ou absente. Une brûlure légère peut se produire au contact d'une antenne endommagée avec la peau. Remplacez immédiatement une antenne endommagée. L'utilisation d'une radio portative alors que l'antenne est absente peut causer des blessures, endommager la radio et pourrait enfreindre la réglementation de la FCC.**



Utilisez seulement l'antenne fournie ou une antenne approuvée. Des antennes non autorisées, des modifications ou des ajouts à une antenne peuvent endommager la radio et enfreindre la réglementation de la FCC. (Reportez-vous à Table 7-1.)

#### 2.4.1.2 Appareils Électroniques



L'énergie des RF provenant de radios portatives peut affecter certains appareils électroniques. La majorité de l'équipement électronique moderne dans les voitures, les hôpitaux, les maisons, etc. est blindé contre l'énergie des RF. Cependant, dans les zones où l'on vous demande de fermer l'équipement de radio bidirectionnelle, respectez toujours les règles. En cas de doute, éteignez-le!

#### 2.4.1.3 Avion



- **Éteignez toujours une radio portative avant d'embarquer à bord d'un avion!**
- **Ne l'utilisez au sol qu'avec la permission de l'équipage.**
- **NE l'utilisez PAS durant le vol!**

#### 2.4.1.4 Détonateurs Électriques



Pour prévenir la détonation accidentelle des détonateurs électriques, n'utilisez PAS de radios bidirectionnelles à moins de 305 m (1 000 pi) des opérations de détonation. Respectez toujours les indications « Éteindre les radios bidirectionnelles » situées là où des détonateurs électriques sont utilisés. (Norme OSHA : 1926.900)

#### 2.4.1.5 Atmosphère Potentiellement Explosive



Les zones ayant une atmosphère potentiellement explosive sont souvent, mais pas toujours, identifiées clairement comme telles. Il peut s'agir de zones d'alimentation en carburant, comme les postes d'essence, les installations de stockage ou de transfert de carburant ou de produits chimiques, ainsi que les zones dont l'air contient des produits chimiques ou des particules, comme des grains, de la poussière ou des poudres métalliques.

Des étincelles dans de telles zones peuvent provoquer une explosion ou un incendie, causant ainsi des blessures ou même la mort.

Éteignez les radios bidirectionnelles dans toute zone ayant une atmosphère potentiellement explosive. Il est rare, mais pas impossible qu'une radio ou ses accessoires produisent des étincelles.

### 3. HAZARDOUS LOCATIONS

This equipment is suitable for use in Class I, Division 1, Groups C and D; Class II, Division 1, Groups E, F and G; Class III, Division 1 hazardous locations; Class 1, Division 2, Groups A, B, C and D or non-hazardous (unclassified) locations only.

Cet équipement convient pour usage en Classe I, Division 1, Groupes C et D; Classe II, Division 1, Groupes E, F et G; Classe III, Division 1 emplacements dangereux; Classe 1, Division 2, Groupes A, B, C et D, ou en sites non-hasardeux (non-classifiés) seulement.



**EXPLOSION HAZARD – REPLACE BATTERY PACK ONLY IN AN AREA KNOWN TO BE NON-HAZARDOUS, AND ONLY WITH L3HARRIS PART NO. 14002-0214-02.**

**AVERTISSEMENT – RISQUE D'EXPLOSION – LES BATTERIES DOIVENT ÊTRE REMPLACÉES DANS UNE ZONE RECONNUE NON-HASARDEUSE SEULEMENT, ET SEULEMENT AVEC UNE BATTERIE L3HARRIS PORTANT LE NUMÉRO DE PIÈCE 14002-0214-02.**



**EXPLOSION HAZARD – Substitution of any component may impair suitability for Class I, Division 1; Class II, Division 1; Class III, Division 1; or Class 1, Division 2.**

**AVERTISSEMENT – RISQUE D'EXPLOSION – Une substitution de toute composante pourrait compromettre la convenance pour la Classe I, Division 1; Classe II, Division 1; Classe III, Division 1; ou Classe 1, Division 2.**



**EXPLOSION HAZARD – Do not exceed maximum battery charging current of 2.0 A or maximum charging voltage of 8.4 V DC at any time.**



**CAUTION - The battery used in this device may present a risk of fire or explosion when heated above 100°C (212°F) or incinerated. Replace battery with L3Harris Part No. 14002-0214-02 only. Use of another battery may present a risk of fire or explosion.**

Battery replacement instructions: Remove battery by 1) depressing battery latches then 2) remove battery from radio chassis. Install replacement battery by inserting battery in radio chassis opening and depressing battery into chassis until both battery latches are engaged. Dispose of used battery promptly. Keep away from children. Do not disassemble and do not dispose of in fire.



**EXPLOSION HAZARD – In addition to any simple single-ended coil antenna or carrying cases, only the following L3Harris accessories may be used with this radio:**

PART NUMBER	DESCRIPTION	APPROVED HAZARDOUS LOCATIONS
MC-011617-701	Standard Speaker Mic - Non-Antenna	US: Class I, Division 1, Groups C and D; Class II, Division 1, Groups E, F and G; Class III, Division 1 hazardous locations; Class 1, Division 2, Groups A, B, C and D  Canada: Class I, Division 1, Group D; Class II, Division 1, Groups E, F and G; Class III, Division 1 hazardous locations; Class 1, Division 2, Groups A, B, C and D
MC-011617-703	Standard Speaker Mic - Non-Antenna	US: Class I, Division 1, Groups C and D; Class II, Division 1, Groups E, F and G; Class III, Division 1 hazardous locations; Class 1, Division 2, Groups A, B, C and D  Canada: Class I, Division 1, Group D; Class II, Division 1, Groups E, F and G; Class III, Division 1 hazardous locations; Class 1, Division 2, Groups A, B, C and D
MC-011617-718	Speaker Mic, Antenna, Straight, 18 in	US: Class I, Division 1, Groups C and D; Class II, Division 1, Groups E, F and G; Class III, Division 1 hazardous locations; Class 1, Division 2, Groups A, B, C and D  Canada: Class I, Division 1, Group D; Class II, Division 1, Groups E, F and G; Class III, Division 1 hazardous locations; Class 1, Division 2, Groups A, B, C and D
MC-011617-730	Speaker Mic, Antenna, Straight, 30 in	US: Class I, Division 1, Groups C and D; Class II, Division 1, Groups E, F and G; Class III, Division 1 hazardous locations; Class 1, Division 2, Groups A, B, C and D  Canada: Class I, Division 1, Group D; Class II, Division 1, Groups E, F and G; Class III, Division 1 hazardous locations; Class 1, Division 2, Groups A, B, C and D
LS103239V1	Earphone for Speaker Mic	US and Canada: Class I, Division 1, Groups C and D; Class II, Division 1, Groups E, F and G; Class III, Division 1 hazardous locations; Class 1, Division 2, Groups A, B, C and D
LS103239V2	Earphone for Speaker Mic	US and Canada: Class I, Division 1, Groups C and D; Class II, Division 1, Groups E, F and G; Class III, Division 1 hazardous locations; Class 1, Division 2, Groups A, B, C and D
12150-1000-03	Speaker Mic, Premium, Fire (FSM), Noise Cancelling, Black	US and Canada: Class I, Division 1, Groups C and D; Class II, Division 1, Groups E, F and G; Class III, Division 1 hazardous locations; Class 1, Division 2, Groups A, B, C and D
12150-1000-07	Speaker Mic, Premium, Fire (FSM), Noise Cancelling, Yellow	US and Canada: Class I, Division 1, Groups C and D; Class II, Division 1, Groups E, F and G; Class III, Division 1 hazardous locations; Class 1, Division 2, Groups A, B, C and D

## 4. CLEANING

Keep the exterior of the radio, battery, antenna, and radio accessories clean.

**Periodically clean using the following procedures:**

1. To remove dust and dirt, clean using damp clean cloth (warm water and mild detergent soap).
2. Follow by wiping with damp (warm water) clean cloth. Wipe dry with clean cloth.
3. Remove the battery and wipe the battery and radio contacts using a soft dry cloth to remove dirt or grease. This will ensure efficient power transfer from the battery to the radio.
4. Remove any accessories and clean the accessories Universal Device Connector (UDC) contacts using a clean dry cloth. When the UDC is not in use, cover the connector with the protective dust cap to prevent the build-up of dust or water particles.
5. If the radio is used in a harsh environment (such as driving rain, salt fog, etc.), it may be necessary to periodically dry and clean the battery and radio contacts with a soft dry cloth or soft-bristle non-metallic brush.

**For more rigorous cleaning, use the following procedure:**



Do not use chemical cleaners, spray, or petroleum-based products. They may damage the radio housing. We recommend using Chemtronics® Electro-Wash® PR (ES-1603) or equivalent.

1. Apply the cleaning solution to a clean damp cloth and clean the radio.



Do not spray cleaning solution directly on radio. To clean the radio in the speaker and microphone areas, carefully wipe these areas but prevent the cleaning solution from entering the speaker or microphone openings.

2. Wipe off the radio with clean damp cloth using mild warm soapy water.
3. Follow up by wiping off the radio with clean damp cloth using warm water only.
4. Wipe dry with clean cloth.

## 5. BATTERIES

The XG-75P series portable radios use rechargeable, recyclable Nickel Metal Hydride (NiMH), Lithium-Ion (Li-Ion), or Lithium Polymer (Li-Poly) batteries. Please read the battery information provided carefully to maximize the useful life of each type of battery.



**Do not disassemble or modify Lithium battery packs. Lithium battery packs are equipped with built-in safety and protection features. Should these features be disabled or tampered with in any way, the battery pack can leak electrolyte, overheat, emit smoke, burst, and/or ignite.**



**If the battery is ruptured or is leaking electrolyte that results in skin or eye contact with the electrolyte, immediately flush the affected area with water. If the battery electrolyte gets in the eyes, flush with water for 15 minutes and consult a physician immediately.**

### 5.1 CONDITIONING BATTERY PACKS

#### 5.1.1 Conditioning NiMH Battery Packs

Condition a new NiMH battery before putting into use. This also applies to rechargeable NiMH batteries that have been stored for long periods (weeks, months, or longer). Conditioning requires fully charging and fully discharging the battery three (3) times using the tri-chemistry charger. The first time the battery is put into the charger, this unit will condition Nickel-based battery packs by automatically charging and discharging (cycling) the battery. Refer to the appropriate charger manual for details.



**Failure to properly condition NiMH battery packs before initial use will result in shortened performance by the battery.**

#### 5.1.2 Conditioning Li-Ion or Li-Poly packs

Lithium battery packs do not suffer from memory effect and do not require conditioning.

### 5.2 STORING LI-ION BATTERY PACKS

If a battery pack is expected to be idle for a month or more, it should be properly prepared. Li-Ion battery packs should not be stored fully charged. Before storing the battery pack, discharge it to 40% capacity. If the battery is not discharged prior to storage, its overall capacity may be reduced. Although all battery packs experience some capacity loss during storage, the shelf life for Li-Ion battery packs is about 3 months. However, note that any capacity drop which occurs during storage is permanent and cannot be reversed. Li-Ion battery packs should be purchased and used immediately. They should not be stock-piled without a rotating stock plan.

---

## 5.3 CHARGING BATTERY PACKS

Battery chargers are available from L3Harris with nominal charge times. Combinations include single and multi-position charge units.

L3Harris chargers are specifically designed for charging nickel-based and lithium battery packs. The chargers are chemistry-specific for the battery packs and automatically adjust the charging profiles accordingly. Refer to the appropriate charger manual for specific operating instructions.

Observe the following guidelines when charging a battery pack:

- Avoid high temperature during charging.
- Discontinue use if the charger is overheating.
- Only charge L3Harris battery packs using a charger approved for use by L3Harris.
- Do not leave batteries in the charger indefinitely. For best results, leave the battery in the charger for two to six hours after the Green Ready LED comes on. Then place the battery pack into service and fully discharge (as indicated by the radio low battery warning) before re-charging.

If any faults are encountered while charging the battery pack, consult the charger's manual to determine the cause and possible corrective action.

## 5.4 BATTERY PACK USAGE

NiMH, Lithium-ion, and Lithium Polymer batteries vary in capacity and life cycle. NiMH, Lithium-ion, and Lithium Polymer batteries require that basic usage guidelines be followed to optimize the battery runtime or shift life.

The following guidelines will help optimize the battery runtime or shift life:

- Ensure Nickel-based battery packs are fully discharged (as indicated by the radio low battery warning) before re-charging. Full discharge is not required for Lithium battery packs.
- Periodically condition Nickel-based battery packs. The frequency should be determined based on usage patterns (refer to ECR-7367). If the battery is fully discharged (to radio Low Battery warning) during routine use, the frequency of conditioning may be reduced. Lithium-ion and Lithium Polymer batteries do not suffer from memory-effect and therefore do not require conditioning.

Do not leave any L3Harris rechargeable batteries in a charger for more than a few days.

## 5.5 ADDITIONAL INFORMATION

For more information regarding the proper care of portable radio battery packs or establishing a battery maintenance program, refer to ECR-7367 which may be ordered by calling toll free 1-800-368-3277 (international - 1-434-455-6403) or via <https://premier.pspc.harris.com/infocenter/>.

## 5.6 CHANGING THE BATTERY PACK

### 5.6.1 Removing the Battery Pack

Make sure the power to the radio is turned off.



Although the XG-75P has been designed to tolerate changing the battery pack without turning power off, L3Harris recommends turning the radio off before changing battery packs to ensure safety and best operation.

Refer to Figure 5-1 and perform the following to remove the battery pack.



1. Press or pull both latches on either side of the battery pack  toward the bottom of the radio simultaneously.
2. Pull the battery  away from the radio.
3. Remove the battery pack from the radio.



Figure 5-1: Removing the Battery Pack



### 5.6.2 Attaching the Battery Pack

Make sure the power to the radio is turned off.



1. Align the tabs at each side on the bottom of the battery pack with the slots at the bottom of the battery cavity .
2. Push the top of the battery pack  down until the latches click to attach the battery to the radio.
3. Tug gently to verify that the latches are secure and the battery pack is properly attached to the radio.



Figure 5-2: Attaching the Battery Pack

## 5.7 BATTERY DISPOSAL



In no instance should a battery be incinerated. Disposing of a battery by burning will cause an explosion.



**RECHARGEABLE BATTERY PACK DISPOSAL** – The product you have purchased contains a rechargeable battery. The battery is recyclable. At the end of its useful life, under various state and local laws, it may be illegal to dispose of this battery into the municipal waste stream. Check with your local solid waste officials for details in your area for recycling options or proper disposal. Canadian and U.S. users may call Toll Free 1-800-8-BATTERY® for information and/or procedures for returning rechargeable batteries in your locality.

## 6. INTRODUCTION

The XG-75P is available in two models: The Scan model with a limited 6-button front-mounted keypad and the System model with a 15-button DTMF front-mounted keypad. The L3Harris XG-75P portable radio delivers end-to-end encrypted digital voice and IP data communications. It is designed to support multiple operating modes including:

- EDACS® (Enhanced Digital Access Communications System) or ProVoice™ Trunked Modes
- P25 Trunked Mode
- P25 Digital Conventional Mode
- OpenSky® Trunked Protocol (700/800 MHz radio only)
- Conventional Analog Mode

The XG-75P portables can include all modes or just one. Additional modes of operation can be added with software updates.

The XG-75P supports a full range of advanced digital trunking features, including talk group calls, priority scanning, emergency calls, late call entry, and dynamic reconfiguration. It performs autonomous roaming for wide area applications. High quality voice coding and robust audio components assure speech clarity.

In the trunked modes, the user selects a communications “operating” system (i.e., EDACS, ProVoice, or P25) and group. While communicating in a trunked mode, channel selection is transparent to the user and is controlled via digital communication with the system controller (e.g., a CSD in an EDACS system). This provides advanced programmable features and fast access to communication channels.

In Conventional Analog mode, the user selects a channel and communicates directly on that channel. A channel is a transmit/receive radio frequency pair.

The exact operation of the radio will depend on the operating mode, the radio’s programming, and the radio system. Most features described in this manual can be enabled through programming. Consult your System Administrator for the features programmed into your XG-75P. Then refer to the corresponding section(s) within this manual for feature and operation information.

The XG-75P series portable radios operate reliably even under adverse conditions. These radios meet MIL-STD-810G specifications for wind driven rain, humidity, and salt fog.

## 7. OPTIONS AND ACCESSORIES

Table 7-1 lists the Options and Accessories tested for use with the XG-75P series portable radios. Refer to the L3Harris Products and Services Catalog for a complete list of options and accessories, including those items that do not adversely affect the RF energy exposure.



**Always use L3Harris authorized accessories (antennas, batteries, belt clips, speaker/mics, etc.). Use of unauthorized accessories may cause the FCC Occupational/Controlled Exposure RF compliance requirements to be exceeded. (Refer to Table 1-1.)**



Always use the correct options and accessories (battery, antenna, speaker/mic, etc.) for the radio. Immersion rated options must be used with an immersion rated radio. Hazardous Location (HAZLOC) options (identified by [FM]) are certified by Factory Mutual (FM) and must only be used with FM certified radios. (Refer to Table 7-1.)



Refer to the product label or HAZLOC certification for class, division, and temperature rating.

**Table 7-1: Options and Accessories**









DESCRIPTION	PART NUMBER	OPTION NUMBER
<b>ANTENNAS</b>		
Helical coil (136-151 MHz) [FM]	KRE 101 1219/1	EVXG-NC1B
Helical coil (150-162 MHz) [FM]	KRE 101 1219/2	EVXG-NC1C
Helical coil (162-174 MHz) [FM]	KRE 101 1219/3	EVXG-NC1D
Helical coil (150-174 MHz) [FM]	KRE 101 1219/21	EVXG-NC5W
Helical stub (378-403 MHz) [FM]	KRE 101 1219/9	EVXG-NC5B
Helical stub (403-430 MHz) [FM]	KRE 101 1219/10	EVXG-NC1U
1/4 - wave whip (378-430 MHz) [FM]	KRE 101 1223/10	EVXG-NC1L
Helical stub (430-470 MHz) [FM]	KRE 101 1219/12	EVXG-NC1F
Wideband whip (764-870 MHz) [FM]	KRE 101 1506/2	MAEV-NNC5X
1/2 - wave (764-870 MHz) [FM]	KRE 101 1506/1	MAEV-NNC5K
Antenna, 764-870 MHz, Flex, End-Fed, Hi Gain	14002-0223-01	EV-NCA
Helical stub (470-512 MHz)	KRE 101 1219/14	MAEV-NNC5Y
¼ wave whip (440-512 MHz)	KRE 101 1223/12	MAEV-NNC1N
Helical stub (470-512 MHz)	KRE 101 1219/13	XXNC1G
<b>BATTERIES</b>		
Nickel Metal Hydride (NiMH) Battery, Immersible	BT-023406-003	MAEV-NPA9X
NiMH Battery, [FM]	BT-023406-004	MAEV-NPA2A
Lithium-Ion (Li-Ion) Battery, Immersible	BT-023406-005	MAEV-NPA9Y
Lithium Polymer, Immersible	BT-023436-001	MAEV-PA2U
<b>CHARGERS</b>		
Power Adapter Kit, VC4000 Charger	PS-007810-001	MAH2-NPS9X
VC4000 Tri-Chemistry Charger	CH-017231-001	MAH2-VC4PB
Single Charger, Tri-Chemistry	CH-104560-007	MAEV-NCH9T
6-bay Charger, Li-Ion/Polymer	12082-0314-01	MAEV-CH4B
Wall Mount Kit, 6-Bay Li-Ion/Poly Charger	12082-0315-01	MAEV-AE4A

DESCRIPTION	PART NUMBER	OPTION NUMBER
Charger, 6-Bay, Tri-Chemistry	CH-104570-007	MAEV-NCH9U
<b>AUDIO ACCESSORIES</b>		
Speaker Mic without Antenna (cc) provision, [FM]	MC-023933-001	MAEV-NAE9D
Rugged Speaker Mic, Antenna, Straight, SBR [FM]	MC-011617-602	MAEV-NAE6D
Earphone for Speaker Mic, [FM]	LS103239V1	MAEV-NAE3Z
Earphone for Speaker Mic, right angle jack	LS103239V2	EV-AE1K
GPS	MC-009104-002	MAEV-NAE9R
Ruggedized Speaker Mic-Coil Cord [FM]	MC-011617-601	MAEV-NAE6C
Standard Speaker Mic - Non-Ant [FM]	MC-011617-701	MAEV-NAE6A
Rugged Speaker Mic, Coiled Cord, Hi-Visibility [FM]	MC-011617-606	EV-AE4C
Speaker Mic, Straight Cord, 25.6in, Antenna	MC-011617-703	MAEV-AE6L
Speaker Mic, Antenna, Straight, 18in	MC-011617-718	MAEV-AE6M
Speaker Mic, Antenna, Straight, 30in	MC-011617-730	MAEV-AE6N
Speaker Mic, Rugged, Coiled, Hirose Port	MC-011617-611	EV-AE4K
<b>DROP SHIP AUDIO ACCESSORIES</b>		
Earphone Kit, Black	EA-009580-001	
Earphone Kit, Beige	EA-009580-002	
2-Wire Kit, Palm Mic, Black	EA-009580-003	
2-Wire Kit, Palm Mic, Beige	EA-009580-004	
3-Wire Kit, Mini-Lapel Mic, Black	EA-009580-005	
3-Wire Kit, Mini-Lapel Mic, Beige	EA-009580-006	
Explorer Headset with PTT	EA-009580-007	
Lightweight Headset Single Speaker with PTT	EA-009580-008	
Breeze Headset with PTT	EA-009580-009	
Headset, Heavy Duty, N/C Behind-the-Head, with PTT	EA-009580-010	
Ranger Headset with PTT	EA-009580-011	
Skull Mic with Body PTT and Earcup	EA-009580-012	
Headset, Heavy Duty, N/C Over-the-Head, with PTT	EA-009580-013	
Throat Mic with Acoustic Tube and Body PTT	EA-009580-014	
Throat Mic with Acoustic Tube, Body PTT, and Ring PTT	EA-009580-015	
Breeze Headset with PTT and Pigtail Jack	EA-009580-016	
Hurricane Headset with PTT	EA-009580-017	
Hurricane Headset with PTT and Pigtail Jack	EA-009580-018	
<b>CARRYING CASE ACCESSORIES</b>		
Black Nylon Case with Belt Loop Kit	<b>14011-0012-01 contains:</b> 14011-0011-01 CC-014527	MAEV-NHC2A
Orange Nylon Case with Belt Loop Kit	<b>14011-0012-02 contains:</b> 14011-0011-02 CC-014527	MAEV-NHC2B
Leather Case with Belt Loop Kit	<b>14011-0012-03 contains:</b> 14011-0011-03 KRY 1011 608/2 CC-014527	MAEV-NHC2C
Leather Case with Shoulder Strap Kit	<b>14011-0012-04 contains:</b> 14011-0011-04 KRY 1011 608/2 CC-014524-001	MAEV-NHC2D
Short Leather Retaining Strap (use with Shoulder Strap application)	CC-014524-002	MAEV-NHC2E
Metal Belt Clip	CC23894	MAEV-NHC2G
Strap Holder, "T"	KRY 101 1656/1	MAEV-NHC2J
Belt Loop, Leather with Swivel	KRY 1011 609/1 FM-017262-001	MAEV-NHC7T
<b>MISCELLANEOUS</b>		
Adapter, UDC, GPS	14002-2014-01	EV-CJ1N
Adapter, UDC, Bluetooth	14002-2015-01	EV-CJ1R

## 8. CHANGE OPERATING MODE

### 8.1 CHANGE FROM OTP MODE

To change from OTP operating mode to EDACS/P25/Conventional (ECP):

1. Use  or  to cycle through the menu until “App Mode” is displayed.
2. Use  or  to choose an available mode. Press  and  or  to confirm (Y/N).
3. Press the  button to confirm.



Or

With a system model radio, press 1# to transition to ECP.

Or

If configured turn the A/B Switch to the A or B position.

### 8.2 CHANGE TO OTP MODE

1. Use  or  to scroll through available systems until OpenSky is displayed and wait.
2. The radio transitions to OTP mode.

## 9. OPENSKY OPERATION



NOTE

OpenSky is only available in the 700/800 MHz model of the XG-75P series portable radios.

Once an OpenSky system has been selected from the available systems on the XG-75P series portable radio, the characteristics described in the following sections will govern operation.

### 9.1 CONTROLS

The XG-75P portable radio features two rotary control knobs, an emergency button, and an A/B switch, all located on the top of the radio (see Figure 9-1). The Push-To-Talk (PTT) button and two option buttons are located to the left side of the radio keypad (see Figure 9-2). The front mounted keypad of the System model has 15 buttons and the Scan model has six buttons (see Figure 9-3 and Figure 9-4).

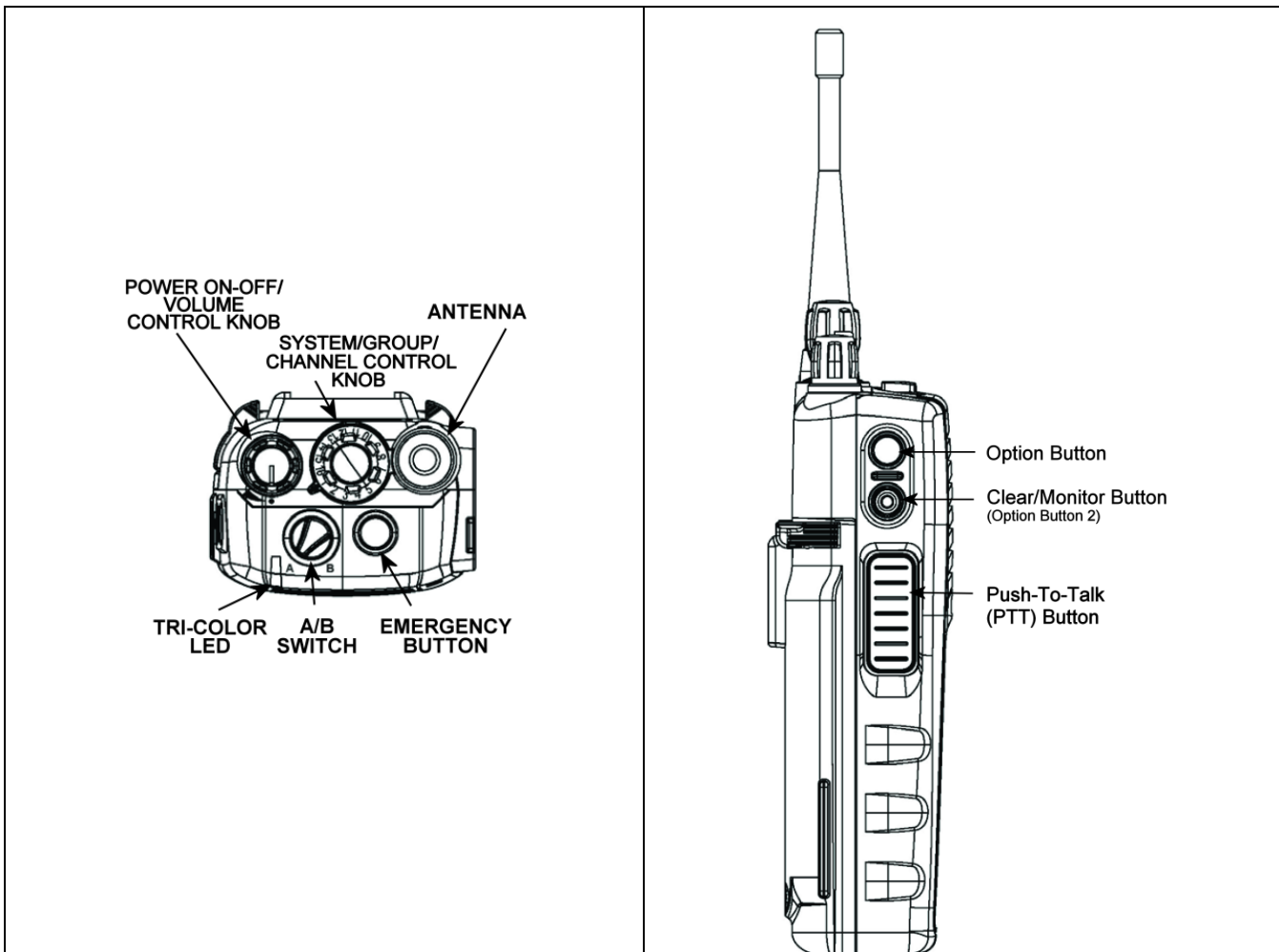





Figure 9-1: Top View

Figure 9-2: Side View

### 9.1.1 Buttons, Knobs, and Switch

The functions of the buttons, knob controls, and dual position A/B Switch vary depending on the mode of operation. Their functions while in the OpenSky mode of operation are discussed in the following paragraphs.

**Table 9-1: Buttons, Knobs, and Switch Functions**

<b>POWER ON-OFF VOLUME KNOB</b>	<p>The Power On-Off/Volume Knob is rotated to apply power to the radio and adjust audio volume up and down.</p> <p>Rotating the control clockwise applies power to the radio. Rotating the control clockwise increases the volume level. Minimum volume levels may be programmed into the radio to prevent missed calls due to a low volume setting. While adjusting the volume, the display will momentarily indicate the volume level (e.g., <b>VOL=39</b>). The volume range is from a minimum programmed level of 1 (displayed as <b>OFF</b> in the display) up to 39, which is the maximum level.</p>
<b>VOICE GROUP SELECTION KNOB</b>	<p>Used to select voice groups when operating within an OpenSky system. This is a 16-position rotary knob. A channel stopper ring (14002-0169-02) is available from L3Harris' Customer Care center. Refer to Installation Guide 14221-1100-4040 for installation instructions.</p>
<b>EMERGENCY BUTTON</b>	<p>Press the emergency button to declare an emergency. To clear an emergency, press and hold the Option 2 button . While holding , press the emergency button. Release both buttons when the "emergency cleared" tone sounds.</p>
<b>PTT BUTTON</b>	<p>The Push-To-Talk button must be pressed before voice transmission begins.</p>
<b>SIDE OPTION BUTTON 1 </b>	<p>Scrolls UP or DOWN through available items within a sub-menu, such as available Talk Groups, pre-programmed speed dial numbers, canned alert messages, etc.</p>
<b>SIDE OPTION BUTTON 2 </b>	
<b>A/B SWITCH</b>	<p>The following settings are configurable via the at@abcs witch command:</p> <ul style="list-style-type: none"> <li>• No Action.</li> <li>• V-TAC Detach (same as *60).</li> <li>• V-TAC Attach (same as *61, *62, or *62 depending on at@c mode setting).</li> <li>• Change to ECP mode.</li> <li>• Scan Mode - No Scan (See Section 9.24.1).</li> <li>• Scan Mode - Normal (See Section 9.24.1).</li> <li>• Scan Mode - Fixed (See Section 9.24.1).</li> <li>• Voice Encryption OFF - If the Selected Talk Group is voice encrypted, disable voice encryption on transmit.</li> <li>• Voice Encryption ON - If the Selected Talk Group is voice encrypted, enable voice encryption on transmit.</li> </ul>

### 9.1.2 Keypad

The front mounted keypad of the Scan model has six buttons and System model has 15 buttons. Refer to Figure 9-3 and Figure 9-4, respectively.

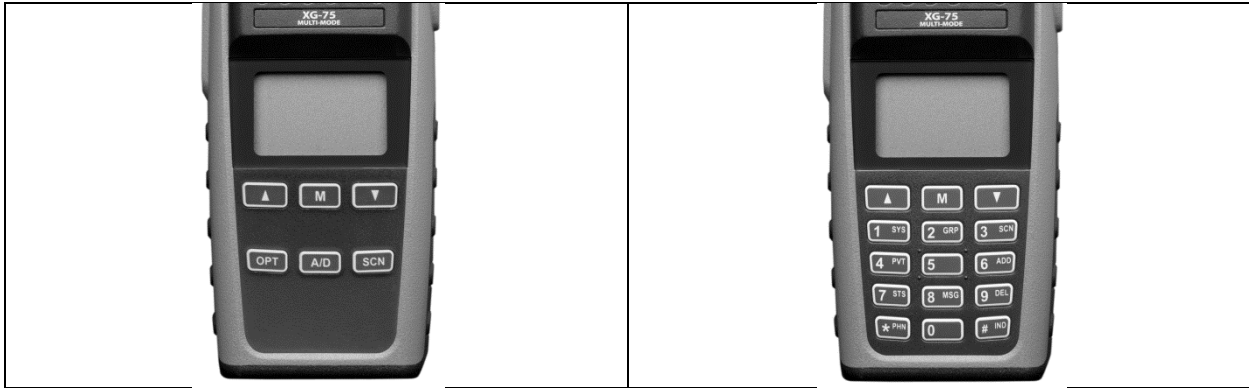

Figure 9-3: Scan Model Front Panel

Figure 9-4: System Model Front Panel

In OTP mode, numeric entry is the primary function of the keys. Each key is described in Table 9-2.

Table 9-2: Keypad Functions

KEY	FUNCTION
	Primary function: Acts much as an “enter” button to activate a selection. Secondary function: While in the “dwell display,” press repeatedly to scroll through and view status display (on 2 <sup>nd</sup> line) for current profile, caller, received Talk Group, and channel.
	Scrolls through available menu items (see Table 9-5).
 (Scan Model only)	Currently undefined in OpenSky mode.
 (Scan Model only)	Toggles scan mode On/Off.
 (Scan Model only)	Currently undefined in OpenSky mode.
 (System Model Only)	The numeric keys are used to enter passwords for logging into the OpenSky network, if not pre-configured for automatic registration at power-up. Also used to place telephone interconnect and individual (unit-to-unit) calls, operating like a normal telephone keypad. Additional functions are also available, such as speed dial, quick access to V-TAC, voice scanning, and Stealth mode operation.
 (System Model Only)	Initiates OpenSky functions (log-in, log out, selective call, telephone interconnect call, etc.). See page 40 for additional information. It is also used as an escape or to clear an entry (something like backspace, but it clears everything, not only the last digit/character).
 (System Model Only)	Used in conjunction with alpha-numeric keys for passwords and OpenSky functions. See page 40 for additional information.



### 9.1.3 Display

The XG-75P display is made up of four lines, each containing twelve alpha-numeric character blocks. The 3<sup>rd</sup> line also contains twelve blocks, each used to display radio status icons. If programmed, the display backlighting will illuminate upon power-up or when radio controls are operated. Specific display characteristics will be discussed in following sub-sections.













Figure 9-5: Radio Display OpenSky Mode

### 9.1.4 Radio Status Icons

Status Icons indicate the various operating characteristics of the radio. The icons show operating modes and conditions and appear on the third line of the display (see Table 9-3).

Table 9-3: Status Icons Descriptions

STATUS ICON DESCRIPTIONS	
OPENSKY ICONS	
	<b>Steady</b> – Received Signal Strength Indicator (RSSI).
	<b>Steady</b> – Radio is data registered.
	<b>Steady</b> – Stealth mode is enabled, all tones and the display backlight are disabled, voice is still heard.
	<b>Steady</b> - Radio is transmitting or receiving an encrypted voice call.
	<b>Animated</b> – The radio is scanning for a V-TAC. Once the radio has attached to a V-TAC, the icon will turn off.
	<b>V-TAC Connection Indicator</b> – Indicates the client is connected to a V-TAC.
	<b>Steady</b> – Indicates Voice Scan mode is Normal or Fixed. Is not displayed when Voice Scan mode is No Scan.
	<b>Steady</b> – Indicates Selective Call mode.
	<b>Steady</b> – Battery charge indicator.
	<b>Flashing</b> – Low battery indicator.

The battery charge indicator illustrates approximate charge only, based on battery voltage.

## 9.2 TRI-COLOR LED



**Figure 9-6: Tri-Color LED**

The Tri-Color LED changes color to indicate radio status and is visible from both the front and top of the radio (see Figure 9-6).

*In OpenSky mode the following radio states are reflected by the LED and the status they represent are:*

Green:	Receiving
Red:	Transmitting
Orange:	If the LED is flashing rapidly, the radio is receiving an emergency call. If the LED is flashing every ½ second, the selected Talk Group is in the emergency state (although not transmitting). If the selected Talk Group is in the emergency state, an asterisk will be displayed next to the Talk Group name.



## 9.3 LOG-IN TO THE NETWORK

Log-in occurs either automatically (auto registration) if the radio has a valid registration or, if enabled, requires the user to enter a User ID and password.



NOTE

The user will be prompted with “Pls Login” if one Talk Group in the selected profile can be encrypted. The user must log-in to use that Talk Group in encrypted mode.

1. Press \*1 keys (Log-in command).
2. Enter the full 10-digit User ID.
3. Press the  key.
4. Enter the password.
5. Press the  key.

The User ID may be remembered from the previous log-in. (Refer to Section 9.4 for further details regarding log-off commands.) The password will be established before the radio is put into operation. Contact the local OpenSky network administrator for more information.



If necessary, contact radio system administration personnel for log-in assistance and/or radio-specific log-in instructions.

## 9.4 LOG OFF THE NETWORK

The \*0## command de-registers the radio. Typically, this is automatically performed when powering down the radio. Using this method, the User ID is remembered by the radio, so only the password is needed at next log-in. If a user is logged in, it is necessary to log-off.

## 9.5 PERSONALITY

As illustrated in Figure 9-7, a personality defines the profiles and Talk Groups available to the user. It is the structuring of a collection of profiles and privileges established by the OpenSky network administrator to provide the user with a comprehensive set of profiles to communicate effectively with the necessary Talk Groups or individuals.

Personalities are stored on the network and downloaded over-the-air to the radio. This process is called “provisioning.” Provisioning occurs at radio power-up (if the personality is not already stored in the radio’s memory) and at user log-in (if the radio has been deregistered). When changes are made to the personality, the radio is automatically re-provisioned. Each personality can contain up to 16 profiles and each profile can contain up to sixteen Talk Groups.

### 9.5.1 Profiles

As stated above, each profile can contain up to 16 Talk Groups. A profile also defines the radio’s emergency behavior. All transmissions are made on the selected Talk Group (displayed on the top line of the dwell display). The user can change the selected Talk Group to any of the other Talk Groups within the profile.

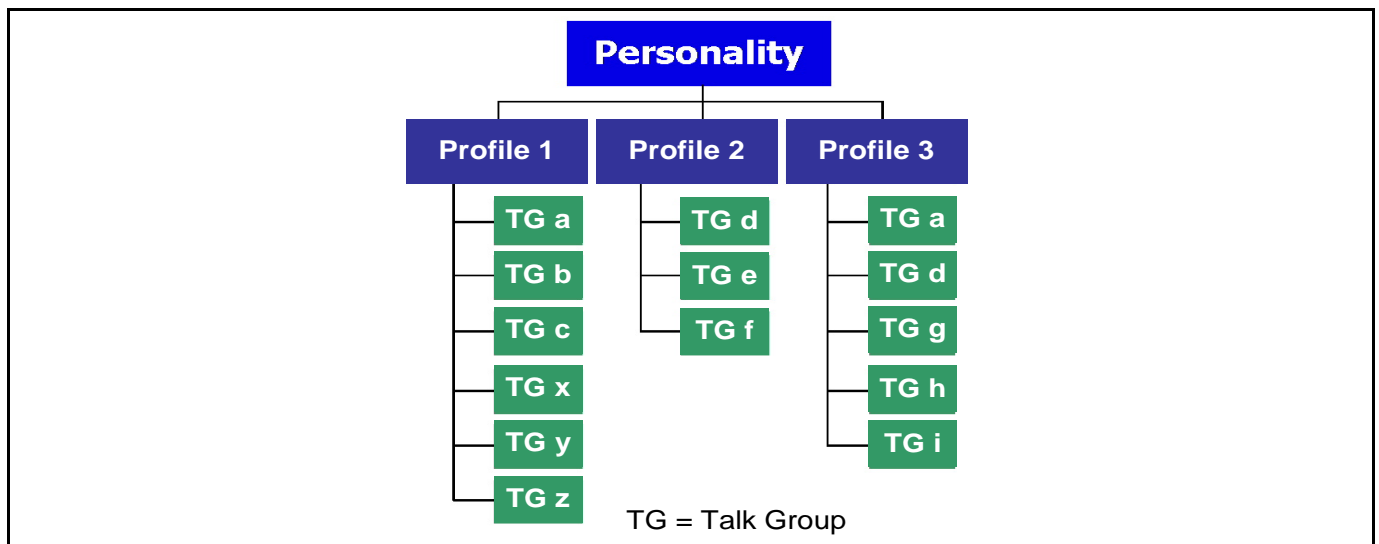

Figure 9-7: Personality Structure Example



### 9.5.2 Talk Groups

A Talk Group represents a set of users that regularly need to communicate with one another. There can be any number of authorized users assigned to a Talk Group. Talk groups are established and organized by the OpenSky network administrator. An OpenSky Talk Group is similar to a channel within a conventional FM radio system.

## 9.6 OPENSKY DISPLAY OVERVIEW

The 12-character x 3-line display shows the radio status. The first two lines of the display are text lines that change in response to user interaction with the menu buttons. Status icons appear in the bottom line (line 3) of the display (see Table 9-3).

### 9.6.1 Display's Top Line

The display's top line of text changes as the  and  buttons are pressed to scroll through the available menu options (see Table 9-5). When the dwell display is present, the selected Talk Group will be displayed. Other information, such as alert messages will scroll across the top line of the display.

### 9.6.2 Display's Second Line

The second line will display information such as active menu, log-in prompt, emergency status, and dwell display messages as described in the following section.

### 9.6.3 Dwell Display

When not engaged in menu selection, the first two lines of the display default to the user-defined display, known as the "dwell display." The top line indicates the currently selected Talk Group. The second line will display the currently selected profile, caller ID/alias<sup>1</sup>, received Talk Group, and current channel name if the channel menu is enabled. Press the  button repeatedly to scroll through and view one of these second line options.

## 9.7 ALERT TONES

The XG-75P radio also provides audible Alert Tones or "beeps" to indicate the various operating conditions (see Table 9-4).

**Table 9-4: Alert Tones**

NAME	STONE	DESCRIPTION
Call Queued	One low tone/two high tones	Call is queued for processing.
Call Denied	Three short beeps	Radio is out of coverage area or requested Talk Group is active.
Grant (or Go-Ahead)	Single short beep	Sounded when resources become available for a call request placed in the queue (if enabled) upon channel access. If the radio roams to another site while transmitting, then it will auto rekey and begin transmitting on that tower. It gives a second grant tone to let the user know they have roamed.
Call Removed	Single long low-pitched tone	Notifies the user access to the channel has been lost (out of coverage area or pre-empted by higher-priority call).

<sup>1</sup> Alias is a logical ID name such as "J\_Smith." The name corresponds to a user ID such as 003-542-0001.

NAME	tone	DESCRIPTION
Low Battery	One low-pitched/one short mid-pitched	Low battery.
Selective Alert Received	Four short tones	Only played once to indicate a selective alert has been received.
Emergency Alert Tone	Three long beeps	Sounds when an emergency alert is declared.
Emergency Cleared Tone	Single long low-pitched tone	Sounds when an emergency is cleared.
Selective Call Ring Tone	A ringing tone similar to a telephone	Ringling is repeated every four (4) seconds until the call is accepted or rejected by the radio being called or until the network drops the call if unanswered after one (1) minute.
Roam Tone	Two short tones, one high-pitched and one low-pitched	Sounds when the radio transitions from one radio base station site to another. While transmitting voice.
Out of Range Tone	Three brief tones	If enabled via programming, sounds at a programmable interval while the radio is in a state of persistent deactivation.
Priority Bump	Single medium mid-pitched tone	Sounds when the current received call is preempted by a higher priority call.
XCOV Connect Tone or Site Found Tone	Three short high-pitched tones	Sounds when a radio connects to a V-TAC in XCOV, XCOV-TG, or XCOV-Prof mode. Sounds when the selected site is found using the Site Lock Menu.
XCOV Disconnect Tone or Site Not Found Tone	Three short high-pitched tones	Sounds when a radio connects to a V-TAC in XCOV, XCOV-TG, or XCOV-Prof mode. Sounds when the selected site is not found using the Site Lock Menu.
Man Down Tone	Single long low-pitch tone followed by a single short high-pitched tone	Sounds when the man down accessory is connected to the radio's UDC port and the radio is a horizontal.



















## 9.8 BASIC MENU STRUCTURE

Table 9-5 illustrates the basic XG-75P OpenSky menu structure. Menu items will vary depending upon system programming, radio hardware, and optional configurations. All menus except the dwell display menu can be turned off by network administration personnel.

**Table 9-5: Basic OpenSky Menu Structure**

MENU NAME	RADIO DISPLAYS	USAGE NOTES
	To/From Dwell Display	
	▼ ▲	
Engineering Display	bit-error rates, RSSI data, sync status, current channel and registration status	Displays radio system connection data. For engineering use.
	▼ ▲	
Silent Emergency	<b>"SilentEmerg"</b>	Use <input type="radio"/> or <input checked="" type="radio"/> to toggle between OFF/ON. Press <input type="button" value="M"/> to enable.
	▼ ▲	
Operating Mode	<b>"App Mode"</b>	Use <input type="radio"/> or <input checked="" type="radio"/> to choose an available mode (OTP, OCF, or ECP). Press <input type="button" value="M"/> and confirm (Y/N) with <input type="radio"/> or <input checked="" type="radio"/> and <input type="button" value="M"/> again.
	▼ ▲	
GPS Fix	<b>"GPS"</b>	GPS latitude and longitude position of currently tuned-to base station ["GPS (Site)"] or V-TAC ("GPS") scrolls across top line of the display. "GPS (Aged)" indicates V-TAC coordinates haven't been updated for more than 2 minutes.
	▼ ▲	
User ID	<b>"User ID"</b>	User's identification/name scrolls across top line of the display (if programmed).
	▼ ▲	
IP Address	<b>"IP Address"</b>	Radio's Internet Protocol (IP) address scrolls across top line of the display.
	▼ ▲	
Station Identification	<b>"Station ID"</b>	Station's identification/name scrolls across top line of the display (if programmed).
	▼ ▲	
Stealth Mode (display backlight is disabled)	<b>"StealthMenu"</b>	Use <input type="radio"/> or <input checked="" type="radio"/> to turn Stealth Mode "On" or "Off." See Section 8.17 for more information about Stealth Mode.
	▼ ▲	
Treble Level	<b>"Treble Menu"</b>	Use <input type="radio"/> or <input checked="" type="radio"/> to choose speaker treble level (LOW, MEDIUM, MEDHIGH, or HIGH). Press <input type="button" value="M"/> to return to dwell display.
	▼ ▲	
Display Brightness	<b>"Bright Menu"</b>	Use <input type="radio"/> or <input checked="" type="radio"/> to brighten or dim backlighting. Press <input type="button" value="M"/> to return to dwell display.
	▼ ▲	
Side Tone Level	<b>"Side Menu"</b>	Use <input type="radio"/> or <input checked="" type="radio"/> to choose side tone level (OFF, LOW, MED, or HIGH). Press <input type="button" value="M"/> to return to dwell display.
	▼ ▲	
See Next Page		

MENU NAME	RADIO DISPLAYS	USAGE NOTES
See Previous Page		
Selected Channel	"ChannelMenu"	Displays the current channel. Press <input type="button" value="M"/> to return to dwell display.
<input type="button" value="v"/> <input type="button" value="^"/>		
Scan Mode	"ScnModeMenu"	Use <input type="radio"/> or <input type="radio"/> to scroll through available scan modes (Normal, No Scan, or Fixed). Press <input type="button" value="M"/> to return to dwell display.
<input type="button" value="v"/> <input type="button" value="^"/>		
Talk group Lock Out	"LockOutMenu"	Use <input type="radio"/> or <input type="radio"/> to choose a Talk Group for locking/unlocking. Press <input type="button" value="M"/> to toggle "<" on (locked out) and off.
<input type="button" value="v"/> <input type="button" value="^"/>		
Priority 2 Talk group	"Priority2"	Use <input type="radio"/> or <input type="radio"/> to choose Priority 2 Talk Group. Press <input type="button" value="M"/> to return to dwell display.
<input type="button" value="v"/> <input type="button" value="^"/>		
Priority 1 Talk group	"Priority1"	Use <input type="radio"/> or <input type="radio"/> to choose Priority 1 Talk Group. Press <input type="button" value="M"/> to return to dwell display.
<input type="button" value="v"/> <input type="button" value="^"/>		
Alerts Received	"Alerts Rcvd" or oldest message	"No alerts" or alert message text scrolls in display. Use <input type="radio"/> or <input type="radio"/> to scroll through all messages.
<input type="button" value="v"/> <input type="button" value="^"/>		
Alert Destination	"Alert Dest"	Use <input type="radio"/> or <input type="radio"/> to choose a speed-dial number. Press <input type="button" value="M"/> to go to the "Alert Msg" menu. Use <input type="radio"/> or <input type="radio"/> to scroll through "canned messages." Press <input type="button" value="M"/> to send message and return to dwell display.
<input type="button" value="v"/> <input type="button" value="^"/>		
Speed Dial	"Speed Dial"	Use <input type="radio"/> or <input type="radio"/> to choose a speed-dial number and press PTT to place call.
<input type="button" value="v"/> <input type="button" value="^"/>		
Profile Selection	"ProfileMenu"	Use <input type="radio"/> or <input type="radio"/> to choose an available profile. Press <input type="button" value="M"/> to return to dwell display.
<input type="button" value="v"/> <input type="button" value="^"/>		
Talk group Selection	"TalkGrpMenu"	Use <input type="radio"/> or <input type="radio"/> to choose a Talk Group in current profile. Press <input type="button" value="M"/> to return to dwell display.
<input type="button" value="v"/> <input type="button" value="^"/>		
Status LED	"Status LED"	Use <input type="radio"/> or <input type="radio"/> to toggle status led "On" or "Off." When On, the LED flashes red when the radio transmits, green when receiving, and amber when in emergency. When Off, the LED will not light at all.
<input type="button" value="v"/> <input type="button" value="^"/>		
Status Message	"Status Msg"	Use <input type="radio"/> or <input type="radio"/> to scroll through available messages. Press <input type="button" value="M"/> to send the selected message.
<input type="button" value="v"/> <input type="button" value="^"/>		
Request to Talk Message	"RTT Msg"	Use <input type="radio"/> or <input type="radio"/> to scroll through available messages. Press <input type="button" value="M"/> to send the selected message.
<input type="button" value="v"/> <input type="button" value="^"/>		
V-TAC Client Mode	"Client Mode"	Use <input type="radio"/> or <input type="radio"/> to choose Client Mode (Network, XCOV, XCOV-TG, or SOI).
<input type="button" value="v"/> <input type="button" value="^"/>		
Emergency Dismiss	"EmgDismiss"	Use <input type="radio"/> or <input type="radio"/> to choose emergency Talk Group. Press <input type="button" value="M"/> to toggle "<" on (dismiss) and off.
<input type="button" value="v"/> <input type="button" value="^"/>		

MENU NAME	RADIO DISPLAYS	USAGE NOTES
See Next Page		
See Previous Page		
Site Lock	“Site Lock”	Use  or  to scroll through sites. Press  to select site.
 		
OTP Software Version	“Software Ver”	Displays OTP software version Press  to return to dwell display.
 		
RF Diagnostics	“Diagnostics”	Use  or  to scroll through RF diagnostics displays. Press  to reset RF diagnostics counters.
 		
Priority 3 Talk Group	“Priority 3”	Use  or  to choose Priority 3 Talk Group. Press  to toggle “<” on (selected) and off.
Use  and  to scroll through menus.		

## 9.9 ERROR MESSAGES

This section lists and describes the error messages that may be displayed by the radio during OpenSky operation.

<b>MESSAGE</b>	<b>DESCRIPTION</b>
<b>NOAUT01</b>	Unspecified MDIS (data switch) error. If condition persists in strong signal conditions, contact your system administrator.
<b>MDENIED</b>	Unspecified MDIS error. If condition persists in strong signal conditions, contact your system administrator.
<b>UNAUTH3</b>	Unauthorized IP. The radio network ID has not been added to network.
<b>UNAUTH4</b>	Bad authentication. If condition persists in strong signal conditions, contact your system administrator.
<b>UNAUTH5</b>	Unsupported authentication. If condition persists in strong signal conditions, contact your system administrator.
<b>MDISBSY</b>	The MDIS is busy. If condition persists in strong signal conditions, contact your system administrator.
<b>DUP IP</b>	Duplicate IP.
<b>BADIKEY</b>	Invalid infrastructure public key sequence number (IPKSN).
<b>BADEKEY</b>	Invalid end-system public key sequence number (EPKSN).
<b>UNK MES</b>	Unknown mobile end system (MES); i.e., radio. If condition persists in strong signal conditions, contact your system administrator.
<b>NOAUT05</b>	MDIS failed mutual authentication. If condition persists in strong signal conditions, contact your system administrator.
<b>BADMDIS</b>	MDIS failed mutual authentication. If condition persists in strong signal conditions, contact your system administrator.
<b>MDS BSY</b>	MDIS busy – retry.



<b><u>MESSAGE</u></b>	<b><u>DESCRIPTION</u></b>
<b><u>UNK DOM</u></b>	Unknown home domain. If condition persists in strong signal conditions, contact your system administrator.
<b><u>KEYSYNC</u></b>	Mismatched key sequence number.
<b><u>UNK ALG</u></b>	Unknown/unsupported encryption algorithm.
<b><u>BADSIZE</u></b>	Unsupported MDIS key size.
<b><u>NOAUT11</u></b>	Radio failed data mutual authentication. If condition persists in strong signal conditions, contact your system administrator.
<b><u>NOAUT12</u></b>	No response from MDIS. If condition persists in strong signal conditions, contact your system administrator.
<b><u>NOREPLY</u></b>	No SME response from MDIS. If condition persists in strong signal conditions, contact your system administrator.
<b><u>VDENIED</u></b>	Unspecified VNIC (voice switch) error. If condition persists in strong signal conditions, contact your system administrator.
<b><u>BAD VID</u></b>	Invalid voice User ID. Check User ID. If correct, contact your system administrator.
<b><u>HOM DWN</u></b>	The Home VNIC is down. Retry. If error continues, contact your system administrator.
<b><u>SRV BSY</u></b>	The serving VNIC is busy (congested).
<b><u>MAX USR</u></b>	The maximum users are already registered with the specified User ID. OpenSky allows one User ID to log onto the network using up to three different radios. Use *0## command or power down one of the other radios to de-register the radio.
<b><u>NAS BSY</u></b>	The system cannot provision radio because of an administrative process.
<b><u>NOAUTHM</u></b>	The radio failed voice mutual authentication. If a valid radio displays this error, contact TAC (see Section 12.2).
<b><u>NOSUPRT</u></b>	The radio cannot support the required provision. If condition persists in strong signal conditions, contact your system administrator.
<b><u>NOAUTHV</u></b>	VNIC does not support or failed mutual authentication. If condition persists in strong signal conditions, contact your system administrator.
<b><u>PLS LOGIN</u></b>	Log-in with keypad.
<b><u>BAD PWD</u></b>	An invalid password has been entered. Verify the password and re-enter.
<b><u>OVER_TEMP</u></b>	The radio may be too hot. The radio will cease transmitting if it exceeds an operational temperature threshold. Let the radio cool before attempting to transmit. Report this failure to authorized technician.
<b><u>No App</u></b>	ECP mode is unavailable (not programmed).
<b><u>NO PRIV</u></b>	Missing required privilege.
<b><u>NO SYNC</u></b>	No forward-channel sync (weak or no coverage). If condition persists in strong signal conditions, contact your system administrator.

<b>MESSAGE</b>	<b>DESCRIPTION</b>
<b>Dead battery</b>	Radio must shutdown because battery charge is critically low.
<b>NO REG</b>	Not registered with MDIS, VNIC, or both.
<b>DISABLED</b>	Function disabled (e.g., function invalid in current context).

## 9.10 KEYPAD FUNCTION COMMANDS (SYSTEM MODEL ONLY)

To perform a command from the keypad, use the keypad commands in Table 9-6.

**Table 9-6: Keypad Function Commands**

<b>COMMANDS</b>	<b>FUNCTION</b>
*0	<b>Log-off command:</b> *0## (logs the user off the system). See Section 9.4 for additional information.
*1	<b>Log-in command:</b> *1<User ID> # <Password> ## (required for encryption). See Section 9.1.3 for additional information.
*2	<b>Status Message:</b> *2 <0...9> #.
*4	<b>Enter Scene of Incident Mode (SOI) on specified channel and band:</b> *4#<Chan>#<Band># where Chan is the channel number that is being used as a SOI repeater and band is the number assigned to each frequency band. For example, if Channel 25 800 MHz (band 0) is being used for SOI, then enter *4#25#0#. <b>Exit SOI Mode with *40#.</b>
*5	<b>RTT Message:</b> *5 <0...9> #.
*7	<b>Initiate Selective Alert command:</b> *7<Target ID>#<Choose Message>#. See Section 9.26 for additional information.
*8	<b>Radio-to-Radio Call command:</b> *8<Selective call number>#(PTT to dial).
*9	<b>Public Switched Telephone Network (PSTN) Call command:</b> *9 <telephone number># (PTT to dial). See Section 9.27 for additional information.
*32	<b>Begin Manual Encryption command:</b> *32<Pre-determined Encryption Key># 1-16 digit enter *32 for 128-bit encryption; 17-32 digit encryption key for 256-bit encryption.
*33	<b>End Manual Encryption command:</b> *33#.
*61	<b>Initiate XCOV Mode:</b> Extended coverage for individual users.
*62	<b>Initiate XCOV-TG Mode:</b> Extended coverage for Talk Groups.
*63	<b>Initiate XCOV-PROF Mode command:</b> *63#.
*60	<b>Exit XCOV or XCOV-TG Mode:</b> Returns to the Network mode.

## 9.11 QUICK KEYS (SYSTEM MODEL ONLY)

Quick Keys are a two-button sequence that provides the user with quick access to certain menu items. Quick Keys function as a toggle for these menu items.



**Table 9-7: Quick Key Sequence**

QUICK KEYS	FUNCTION
1#	<b>Transition to ECP Mode</b> If ECP code is not loaded in the radio, "No App" appears in the display.
2#	<b>Toggles Stealth Mode On/Off</b>
3#	<b>Toggles Scan Mode On/Off</b> (Normal/Fixed, see details below) <ul style="list-style-type: none"> <li>If the Scan Mode is Normal when the Scan Mode is toggled Off, the Scan Mode will be Normal when toggled On again.</li> <li>If the Scan Mode is Fixed when the Scan Mode is toggled Off, the Scan Mode will be Fixed when scan mode is toggled On again.</li> <li>If the Scan Mode is Off when the radio boots up, the Scan Mode will be Normal when Scan Mode is toggled On.</li> </ul>
4#	<b>Lights/Tones On/Off</b> Pressing 4# turns the TX/RX LEDs, Backlight, and Side Tones On/Off. If any of the TX/RX LEDs, Backlight, and/or Side Tones are On, and this quick key sequence is used, then all the TX/RX LEDs, Backlight, and Side Tones are turned Off. If the radio is in Stealth mode, this quick key is disabled since the user is not able to turn on the light/tones in stealth mode.
5#	This quick key sequence is used to set the current active profile to the default profile in the personality as defined in the UAS.
6#	<b>XCOV &amp; XCOV-TG Attach/Detach</b> This quick key sequence is used to manually connect to a V-TAC. When attaching to a V-TAC, the radio's programming determines whether to attach to the V-TAC in XCOV or XCOV-TG mode. <ul style="list-style-type: none"> <li>If the user attaches to a V-TAC manually, using the *61# or *62# command sequence, the radio is understood to be attached and this quick key sequence will detach the radio from the V-TAC.</li> <li>If the user detaches manually from a V-TAC using the *60# command sequence, the radio is understood to be detached and this quick key sequence will attach the radio to a V-TAC.</li> <li>At bootup, the radio is understood to be detached from a V-TAC. If a radio automatically attaches to a V-TAC, the radio is still understood to be detached from a V-TAC and will attempt to attach to a V-TAC.</li> <li>If a radio manually attaches to a V-TAC and then is automatically detached from a V-TAC, the radio will attempt to attach to another V-TAC.</li> </ul>
7#	This quick key sequence is used to transmit the RTT Automatic Normal Message to the console.
8#	This quick key sequence is used to transmit the RTT Automatic Priority Message to the console.

## 9.12 DTMF OVERDIAL

Using the keypad on a System Model, the radio can transmit DTMF tones corresponding to numbers/characters 0 - 9, \*, and # on the keypad. To over dial numbers/characters, transmit by pressing and holding the PTT button and then, press the corresponding keys (one at a time) on the keypad.

## 9.13 LOCK/UNLOCK THE KEYPAD









1. Press and hold the  button.
2. While holding the  button, press the  button on the side of the radio.

## 9.14 DUAL-TONE MULTI-FREQUENCY (SYSTEM MODEL ONLY)

Dual-Tone Multi-Frequency (DTMF) is the system used by touch-tone telephones. DTMF assigns a specific set of tone frequencies to each key. This allows for specific tasks such as entering a user ID and password, or selective calling. When a key on the DTMF keypad is pressed, the DTMF tone is played through the radio's speaker.

## 9.15 CHANGING THE ACTIVE PROFILE





The radio can store up to 16 standard profiles, one of which is the currently active profile. To change the currently active profile:

1. Press the  or  buttons until "ProfileMenu" is displayed.
2. Use  or  to scroll through the list of available profiles.
3. Profile becomes active when selected for longer than 2 seconds, when the  is pressed, or when the menu is changed using the  or  button. Press  to activate the selected profile.

## 9.16 CHANGING THE SELECTED TALK GROUP

Each profile stored in the radio can have up to 16 Talk Groups. One Talk Group within the currently active profile is set as the "selected Talk Group." To change the selected Talk Group, turn the Group Selection knob on top of the radio or use the Talk Group selection menu.

## 9.17 ADJUSTING DISPLAY AND BUTTON BACKLIGHT BRIGHTNESS

1. Press the  or  buttons until **Bright Menu** is displayed.
2. Use  or  to brighten or dim the display and button backlighting.





## 9.18 STEALTH MODE

For some users, it is important to be able to turn off the radio's display lights and side tones, but not the radio traffic. For example, in covert operations, lights and sounds could inadvertently expose an otherwise unobservable radio user. For this purpose, the radio has a Stealth feature that disables the radio display lights, indicator lights, audible alert, and side tones.

When Stealth Mode is on, the radio continues to scan the programmed list of Talk Groups and the user can key-up on the selected Talk Group.

### 9.18.1 Enabling Stealth Mode

**System Model only:** Quick Key combination 2# toggles Stealth Mode on and off.

**Both models:** Press the  or  buttons to scroll through menus until "StealthMenu" appears in the display. To immediately activate Stealth Mode, press the  or  button once. This activates Stealth Mode, exits the Stealth Menu, and returns to the Dwell Display.

The display lights, indicator lights, and side tones are disabled. The stealth mode icon is displayed.

### 9.18.2 Disabling Stealth Mode

**System Model only:** To re-enable all lighting, side tones and exit Stealth Mode, press Quick Key combination 2# again. The radio returns to the Dwell Display.



NOTE

Stealth Mode can also be disabled by using the Stealth Menu.

**Scan Model only:** To re-enable all lighting, side tones, and exit Stealth Mode, press any key other than PTT or Emergency. The radio returns to the Dwell Display.

The display lights, indicator lights, and side tones are re-enabled. The stealth mode icon disappears.

## 9.19 ADJUSTING SIDE TONE AUDIO LEVEL

The radio sounds confirming tones called “side tones” when its buttons are pressed. Most users find this audible confirmation helpful when navigating the menus. Side tone audio level can be adjusted or turned completely off using the “Side Menu” or the Quick Key combination #4.







NOTE

Quick Key combination 4# turns off the backlight in addition to the side tones. Unlike Stealth Mode, alert tones can still be heard.

For covert operations, it may be necessary to turn off side tones. For safety’s sake, turning off the radio during covert operations is not recommended.

If the radio is operating properly but side tones are not heard when the menu buttons are pressed, the side tones are probably turned off. To turn them back on, access the “Side Tone” menu and select a setting other than “off.”

Use the following procedure set side tone level:

1. Press the  or  buttons to cycle through the menu until “Side Menu” is displayed.
2. Press  or  to change to the desired level (Off, Low, Medium, and High). To turn side tones off completely, use the “Off” setting.





## 9.20 CHANGE OPERATING MODE

### 9.20.1 From OTP to ECP Mode

**Method 1 (Quick Key, System Model only):**

Press 1#. If ECP is not loaded in the radio, the radio displays “No App.”

**Method 2:**

1. Press the  or  buttons to cycle through the menu until “App Mode” is displayed.
2. Press  or  to select the desired operation mode.

3. Press **[M]** and use **[O]** or **[⊕]** to select Y or N.
4. Press **[M]** to make selection and return to the dwell display.
5. “Restart Please Wait” appears in the display as the radio switches modes.

**Method 3:**

If configured, turn the A/B Switch to the A or B position.

**9.20.2 From ECP to OTP Mode**

Press the **[▼]** or **[▲]** buttons to cycle through available systems until “OPEN SKY” appears in the display. Pause briefly and the radio will switch automatically from ECP to OTP operation.

**9.21 RECEIVING AND TRANSMITTING VOICE CALLS**

As soon as the radio completes the initialization sequence and registers on the OpenSky network, the user will begin to hear calls from the Talk Groups in the active profile, if available.

**9.21.1 Receiving a Voice Call**

No action is required to receive a voice call. The display responds to incoming voice calls as follows:

- When the dwell display is set to received Talk Group and the scan mode is Normal or Fixed:
  - a. If the received Talk Group matches the selected Talk Group, then the alias (if available) or user ID of the incoming caller is displayed.
  - b. If the received Talk Group does not match the selected Talk Group, then the received Talk Group name is displayed.
- When the dwell display is set to received Talk Group and the Scan Mode is None, the radio only receives voice on its selected Talk Group. When the call is received, the alias (if available) or the user ID of the incoming caller is displayed.
- When the dwell display is not set to received Talk Group, then there is no display indication of an incoming call.







A radio receiving a System All Call, Regency All Call, or an Agency All Call displays “All Call” instead of the alias. A radio not transmitting on a Talk Group in emergency status will drop all other calls to scan into an All Call.

**9.21.2 Transmitting a Voice Call**

1. Select the desired Talk Group.
2. Depress and hold the **PTT** button, wait a couple of seconds. If programmed by the administrator, a grant tone will be sounded.
3. Begin speaking into the microphone in a normal voice.
4. For maximum clarity, hold the radio approximately 2 inches from your mouth. Take care not to cover up the microphone while speaking.
5. Release the **PTT** button to terminate an outgoing voice call.

## 9.22 ADJUSTING AUDIO TREBLE LEVEL

The tone of received signals can be adjusted using the radio's "Treble Menu."

1. Press the  or  buttons to cycle through the menu until "Treble Menu" is displayed.
2. Press  or  to increase or decrease level. There are four levels available: low, medium, medium-high, and high.
3. Press  or wait a few seconds to return to the dwell display.

## 9.23 TALK GROUP LOCK OUT

There are two ways to focus voice communications by suppressing calls from Talk Groups in the active profile.

- **No Scan.** By changing the Scanning Mode to "No Scan" only the selected Talk Group is scanned.
- **Lock Out.** By locking out selected Talk Groups, background noise or chatter can be eliminated, and scanning resources can be focused on just those groups whose calls you wish to monitor.



NOTE

Lock out is a listening (receive) function and only blocks received calls on locked out Talk Groups. Lock out does not affect transmit capability. "No Scan" and "Lock Out" do not apply to recent emergency lock outs.

Only Talk Groups in the active profile can be locked out, since they are the only Talk Groups whose voice calls can be heard on the radio. Talk group lock out is a scan-related feature. With lock out, one or more Talk Groups in the active profile can be temporarily disabled from being scanned. Calls are not received on locked-out Talk Groups. Lock out settings are not retained between profile changes.







NOTE





P1, P2, and P3 groups **CANNOT** be locked out.

The default emergency and emergency-capable Talk Groups can be locked out if they are **NOT** in an emergency state. If a Talk Group is locked out and is subsequently changed to the currently selected Talk Group, it will automatically be unlocked by the radio so the user can hear calls on the Talk Group. The radio may be configured so all Talk Groups are automatically locked out by default. In this case, they must be manually unlocked, if desired.

### 9.23.1 Lock Out a Talk Group

1. Use the  or  buttons to scroll through the menu choices until "LockOutMenu" appears in the display.
2. Use the  or  keys to scroll through the list of Talk Groups, if any, until the user group you want to lock out appears in the display.
3. Press the  key to select the lockable Talk Group.
4. "<" appears next to the locked-out Talk Group.

### 9.23.2 Unlock a Talk Group

1. Use the  or  buttons to scroll through the menu choices until “LockOutMenu” appears in the display.
2. Use the  or  keys to scroll through the list of Talk Groups, if any, until the user group you want to unlock appears in the display.
3. Use the  key to unlock the displayed Talk Group.



NOTE

- Changing the active profile removes any lockouts you have made.
- Turning off the radio removes any lockouts you have made.

## 9.24 SCANNING

### 9.24.1 Selecting Scan Modes

Three scanning modes are available for the radio, but only one can be active at any time. Changing the scanning mode changes the way the radio scans voice calls for all the profiles in the radio personality, no matter which profile is or becomes active.

The choice of scanning mode broadens or narrows the span of communications with all the groups in profiles you listen to, but does not affect your interaction with those groups you talk with. The scanning modes available for selection may be limited by the administrator to a subset of the three scanning modes.

**Table 9-8: Scan Modes**





SCAN MODE	EXPLANATION
<b>None</b>	<b>Eliminates distractions.</b> Full communications (listen and talk) with the selected Talk Group. No calls received from other Talk Groups.
<b>Normal (Default)</b>	The user can scan all Talk Groups in the active profile that are not locked out as long as there is demand on the site. Priority (P1, P2, and P3) groups are user selectable. Receive calls from more than one Talk Group, if available from the current site. Allows dragging of the selected Talk Group, P1, P2, P3, and emergency Talk Group (in emergency state) to the site on which the radio is registered. (If other calls are available at the site, they also can be heard but they will not be actively dragged.) The default emergency Talk Group, as well as any emergency-enabled Talk Groups, is only dragged if it is in emergency mode.
<b>Fixed</b>	Functions the same as Normal Scan Mode, except the priority groups are fixed to the selected profile's pre-defined P1 and P2 groups (configured via the UAS).

The scanning mode choice remains in effect until it is changed. Even if the radio is turned off, the current scanning mode selection is saved for the next use.



## 9.24.2 Changing Active Scan Mode

### 9.24.2.1 Setting the Scan Mode

1. Press the  or  buttons until “ScnModeMenu” appears in the display.
2. Use the  or  keys to scroll through the list of modes until your choice appears: Normal, None, or Fixed.
3. Press the  key to activate the scan mode selection and return to the dwell display.

### 9.24.2.2 Duration of Scanning Mode Selections





Scanning Mode selections survive power down. At startup, the radio defaults to the scanning mode of set during last use. The last selection made remains in effect until a new selection is made from the Scan Mode menu.

### 9.24.3 Scanning Priority

The following lists the scanning priority order (from highest to lowest):

- Selected Talk Group in emergency state.
- Default emergency group in emergency state.
- Selected Talk Group.
- Emergency capable group in emergency state.
- Priority 1 Talk Group.
- Priority 2 Talk Group.
- Priority 3 Talk Group.
- Other (non-priority).

#### 9.24.3.1 Changing Scan Priority





1. Press the  or  keys until “Priority 1” or “Priority 2” appears in the display (Priority 1 group has higher priority than the Priority 2 group).
2. Press the  or  button until the desired Talk Group is displayed.
3. Press the  key to select and activate the selection. The radio automatically returns to the Dwell Display.



NOTE

- Changing the priority of a listen group does not change your Talk Group.
- Priority can be set for six Talk Groups (Priority 1, Priority 2, and up to four Priority 3), but only in the selected profile.
- If the save settings is configured for the radio, scanning priority settings are saved when the radio is turned off. Otherwise, they are reset to the default values when the radio is turned off.

### 9.24.3.2 Changing Scan Priority 3 Talk Groups

1. Use the  or  buttons to scroll through the menu choices until “Priority 3” appears in the display.
2. Use the  or  keys to scroll through the list of Talk Groups, if any, until the user group you want to set as Priority 3 appears in the display.
3. Press the  key to select a Priority 3 Talk Group.
4. “<” appears next to the Priority 3 Talk Group.

### 9.24.4 Scan Mode A/B Switch

The A/B switch can be configured to toggle Scan Mode On/Off.

If the Scan mode icon (see Table 9-3) is On; either the Normal or Fixed Scan modes are enabled, depending on programming. If the Scan mode icon is not displayed, Scan mode is set to No Scan.

### 9.24.5 Scan Mode Quick Key (System Model Only)

Press 3# to toggle Scan mode on and off.

If the Scan mode icon (see Table 9-3) is On; either the Normal or Fixed Scan modes are enabled, depending on programming. If the Scan mode icon is not displayed, Scan mode is set to No Scan.

## 9.25 MAKING SELECTIVE CALLS

Selective calling is the capability for two voice radio units to obtain and use an independent talk path for a unit-to-unit call. A properly equipped radio can initiate a selective call to any radio in the system that is also programmed for selective calls.

In the OpenSky system, a radio can be configured to initiate selective calls through a pre-programmed list in memory called a speed dial list. Alternatively, a properly equipped radio can initiate a selective call to any radio in the system by entering the ten-digit User ID (similar to a telephone number) of the target radio. Some radios are configured to only receive (not initiate) selective calls.



NOTE

Selective calls are terminated if an emergency is declared. The network limits selective calls to ten (10) minutes maximum.



NOTE

If a Selective Call is attempted without registration, “No Priv” is displayed.

### 9.25.1 Manually Dialing a Selective Call (System Model Only)

1. Enter \*8, the User ID number of the user being called, and the # key (no dashes or spaces). ***This feature must be enabled by the administrator.***

\*8<destination user id>#

A shortened User ID number can be dialed using the following guidelines:

- If the radio being called is in the same region and agency – enter only the last four digits.
  - If the radio being called is in the same region, but a different agency – enter only the last seven digits.
  - If the radio being called is in another region or if the area is unknown – enter all ten digits.
2. Press the PTT (and release) to ring the other user.

The ring tone is sounded.

If the other user accepts the call, the called user's alias will appear in initiating caller's display. The two are now in a unit-to-unit call until one ends the call, the call is terminated due to an initiated emergency, or the maximum time limit of ten (10) minutes is reached.

If the called radio is busy, "BUSY" will appear in the second line of the display.

Table 9-9 lists and defines the messages that are displayed by the radio during a selective call.

**Table 9-9: Status of Selective Call**

STATUS MESSAGE	DEFINITION
Busy	Peer is involved in another selective/PSTN call.
Disconnect	Selective/PSTN call was terminated for unknown reason.
Network Err	Selective/PSTN call cannot continue because of an unspecified network error.
Reject	Peer or this user declined request to establish selective/PSTN call.
Unavailable	Peer cannot be reached for selective/PSTN call.
Calling	Calling peer (i.e., for selective or PSTN calls).
Connecting	Establishing selective/PSTN call with peer.
Hangup	Peer or this user terminated selective/PSTN call.
Lim 10 min	Selective/PSTN call limited to 10 minutes.
Timing Out	Selective/PSTN call has 10 seconds remaining before limit is reached (shown for 5 seconds).
Sel Call	Selective call is active.

### 9.25.2 Selective Call Using Speed Dial



NOTE

Speed dial numbers are defined and provisioned by the OpenSky network administrator and cannot be manually entered into the radio by the user. Contact the administrator if changes to the speed dial list are required.

- Scroll through the Menu options using the or button until "Speed Dial" appears in the second line of the display. Using the or keys, scroll through the pre-programmed speed-dial numbers until the desired number appears in the display and press the PTT button.

OR



- Press and hold a key associated with a given number for more than three seconds. For example, press and hold the  to open the Speed Dial Menu and display the number assigned to that key in the speed dial list. Press the PTT button.

A ring tone is sounded.



If the other user accepts the call, the called user's alias will appear in initiating caller's display. The two are now in a unit-to-unit call until one ends the call, or the call is terminated due to an initiated emergency.

If the called radio is involved in another selective call, "BUSY" will appear on the second line of the display. "Unavailable" is displayed when the call has not been answered after a 1 minute timeout or when the other party is not registered on the network.



### **9.25.3 Accepting a Selective Call**

1. The radio will ring (like a telephone), indicating you are receiving a Selective Call.
2. Press , , or  buttons to accept the incoming Selective Call.
3. "CONNECT" appears in the display, followed by "Lim 10 Min.," "SEL CALL," and the alias of the caller, once the call is established.

### **9.25.4 Rejecting a Selective Call**

When a Selective Call is received (the radio is ringing), you can reject the call by pressing  or . The call is rejected and "Reject" appears on the caller's display.

### **9.25.5 Terminating a Selective Call**

Terminate a Selective Call (call must be active) by pressing the  or  button. "HANGUP" will appear in the display followed by the active Talk Group.

## **9.26 SELECTIVE ALERTS**

Selective alert messaging is an OTP feature that allows one of up to eight (8) pre-programmed (canned) text messages to be sent from one radio to another. The sender specifies a destination (receiving) radio, selects one of the pre-programmed text messages, and then transmits it to the destination radio. The message delivery system adds sender and time-of-day information and forwards the message to the destination (receiving) radio. The sending radio receives a brief message noting the status of the transmission.

Received messages are stored in the radio until deleted or until the radio is rebooted. Received messages do not survive a reboot.

### **9.26.1 Defining Messages**

All selective alert messages are pre-defined. The messages are programmed and provisioned remotely by your OpenSky system administrator. The radio user cannot create selective alert message content. The entire selective alert message, including the abbreviation, can be up to 99 characters long.

Table 9-10 lists and defines the messages that may be displayed by the radio during a Selective Alert.

**Table 9-10: Status of Selective Alert Messages**

STATUS MESSAGE	DEFINITION
Alert Sent	Alert message successfully sent to target.
Delivered	Alert message passed to network.
Delivering	Delivering alert message to target.
New alert	New alert message received.
No alerts	No alerts are available.
Busy	VNIC congested and cannot deliver message at the current time.
Dest Down	Destination home VNIC down.
Ignored	Destination is either non-responsive or does not care to respond.
Inv Option	Distribution option is invalid.
Not Reg	Destination is not registered.
Partial	Not all destination ESN instances reachable.
Unauth Alrt	Unauthorized service function; initiator is not authorized to send the selected service message.
Unknown Msg	Unknown status received from VNIC.
Unreachable	Alert destination cannot be reached.

### 9.26.2 Sending a Message

The sending process has three steps. First select the destination radio's User ID, then select the alert message, and finally send the message. Refer to the procedures in subsections 9.26.2.1 or 9.26.2.2 for instructions on selecting a destination for a Selective Alert Message.









#### 9.26.2.1 Selecting a Destination Using the Keypad (System Model Only)

- Using the keypad, enter \*7.

At the "AlertDst" prompt, enter the full *User ID* of the unit to send the message. A shortened User ID number can be dialed using the following guidelines:

- If the radio being called is in the same region and agency – enter only the last four digits.
  - If the radio being called is in the same region, but a different agency – enter only the last seven digits.
  - If the radio being called is in another region or if the area is unknown – enter all ten digits.
- Press the **#IND** key to activate the selection.
  - Use the **○** and **⊙** buttons, or the **4 PRT** and **6 ADD** buttons to scroll through the available messages until the desired message is displayed.
  - Press the **M** or **#IND** key to send the message.
  - Observe Status Messages (Table 9-10) to ensure proper delivery.

### 9.26.2.2 Selecting a Destination Using the Menu





1. Using the  or  key, scroll through the menu until “AlertDst” (Alert Destination) appears.
2. Use the  or  button to scroll through the list of User IDs until the desired destination is displayed and press the  key.
3. Use the  or  buttons to scroll through the available messages until the desired message is displayed.
4. Press the  key to send the message.
5. Observe Status Messages (Table 9-10) to ensure proper delivery.

### 9.26.3 Receiving a Message





When a selective alert message is received by a radio, a four-beep tone is heard. The tone is heard only once, but the message “NEWALRT” alternates with the Talk Group on the main display. Up to eight received messages can be stored. If a ninth message is received, the first (oldest) message is automatically deleted to make room for the new message.

Received messages are displayed with the time and source information.

To display a Selective Alert Message:

1. Using the  or  button, scroll through the menu items until “Alerts Rcvd” appears. The oldest message is displayed and scrolls across the top line of the display.
2. The message includes the time, the User ID, and alias of the sender along with the message.
3. To view the next message, press  or .

### 9.26.4 Deleting a Selective Alert Message

1. Display the message.
2. Press the  key and  or  to select Y or N.
3. At the “Delete? Y” prompt, press the  key. The message will be deleted.





Received messages cannot be saved.

## 9.27 MAKING INTERCONNECT CALLS (SYSTEM MODEL ONLY)

1. Using the keypad, enter \*9, followed by the telephone number being called, and the # key (no dashes or spaces).

*\*9<telephone number>#*

Wait a couple of seconds and press and release the PTT button to initiate the call. An initial ring tone will sound to indicate signal call initiation. Once the gateway picks up the call, the ring tone will change. Press and hold the PTT and talk normally, then release the PTT to listen.

2. To hang up the call, press  or the  key.

## 9.28 EMERGENCY COMMUNICATIONS

The XG-75P portable radio can send an emergency alert and making emergency calls on the network. The OpenSky system handles emergency calls with the highest priority, allowing you or the people you serve to get needed help.

Emergency call and alert capability for a profile is configured by the system administrator.



The radio that initiates an *emergency alert* emits a signal of three distinct beeps that only goes to the dispatch console.

**Table 9-11: Emergency Calls vs. Emergency Alerts**

EMERGENCY ALERT	EMERGENCY CALL
An Emergency Alert message is sent to the dispatcher console. The dispatch console plays an emergency tone when it receives the message.	An Emergency Alert message is sent to the dispatcher console. All peers (radios and consoles) and the dispatch console play the emergency tone whenever an emergency call is detected. An emergency tone plays for each new emergency, or when a profile is changed, (assuming there is an emergency on one of the Talk Groups for the new profile).  If the orange LED is flashing rapidly, the radio is receiving an emergency call. If the LED is flashing every ½ second, the selected Talk Group is in the emergency state (although not transmitting). If the selected Talk Group is in the emergency state, an asterisk displays next to the Talk Group name.
No emergency audio (voice) transmission (hot-mic) capability available (per programming by system administrator)	In addition to the Emergency Alert signal, the microphone goes hot for a predetermined length of time to allow for emergency audio (voice) transmission. The radio declaring the emergency has channel access priority. The User can also use the PTT after the pre-determined hot-mic audio transmission, or during to extend the initial hot-mic audio transmission.

### 9.28.1 Declaring an Emergency Call or Alert

1. Press the red emergency button on the radio to enter emergency mode.



The emergency behavior for the selected profile is configured by the network administrator. This determines whether pressing the Emergency button sends an Emergency Call or just an Emergency Alert. An Emergency Alert is always *part of* and *sent with* an Emergency Call.

If the active profile of the unit initiating the emergency is configured to Emergency Alert, the three-beep emergency alert signal is sent only to the dispatcher console.

If the active profile of the unit initiating the emergency is configured to Emergency Call, the three-beep emergency alert signal is sent to the dispatcher console and to all other radios within the selected Talk Group. The default emergency Talk Group becomes the selected Talk Group. The display will alternate between the emergency Talk Group name and “EMERGENCY” to indicate that the emergency has been initiated.

2. The microphone is hot (open mic) for a programmed amount of time to send your voice out on the emergency Talk Group.

If the attempt is unsuccessful, “E-PEND” flashes periodically and a retry is queued for 10 seconds. If unsuccessful because of lost sync, retry occurs immediately upon reacquiring sync. On each

retry attempt, the radio temporarily displays “E-RETRY.” This process repeats until the emergency is successfully declared.

### 9.28.2 Receiving an Emergency Call

When receiving an emergency call, the radio sounds the emergency tone (three short high-pitched tones).

The radio will flash “EMERGENCY” and display the alias of the user that triggered the emergency or the alias of the Talk Group (if the incoming Talk Group is the selected Talk Group of the receiving radio).

With “No Scan,” only the emergency tone is heard, not the initial open mic transmission.

To dismiss or ignore the emergency, refer to Section 9.28.3.



### 9.28.3 Dismissing an Emergency

The “Dismissing an Emergency” function allows you to “ignore” an emergency declared by another user.



NOTE

An emergency is dismissed for a configurable amount of time (default = 5 minutes).

1. After receiving an emergency call, press the  or  button until you see “EmgDismiss.”
2. Press the  to toggle “<” on (dismiss) and off. This works in similar fashion to the lock out menu.



NOTE



The emergency dismiss timer is cleared when the emergency is cleared.

### 9.28.4 Clearing an Emergency Call or Alert



NOTE

Check with your system administrator to ensure that your radio is configured with the ability to clear an emergency.

1. To clear an emergency, press and hold . While holding , press the emergency button. Release both buttons when the “emergency cleared” tone sounds.
2. The radio returns to your default selected Talk Group. The “EMERGENCY” display is removed from the main screen.



NOTE

If the radio is in stealth mode, clearing the emergency will cause the radio to exit stealth mode.



## 9.29 OPENSKY ENCRYPTION

In the OpenSky network, both data and voice use a 128-bit or 256-bit key encryption standard published by the Federal Information Processing Service (FIPS), called Advanced Encryption Standard (AES). AES is approved by the U.S. Department of Commerce for encryption of classified materials.

When encryption is enabled on the network, data is encrypted from the MDIS to the Mobile End System (MES) (e.g., XG-75P portable radio). This form of encryption provides airlink security.

Voice encryption is handled either automatically or manually. Automatic encryption is initiated through the Unified Administration Server (UAS) for a specific Talk Group and requires nothing from the radio user. Manual encryption is initiated by two or more radio users. Both methods of encryption are discussed in the following sections.



NOTE

When a user transmits encrypted voice, any listening users with different encryption keys hear distorted voice and “No Access” appears in the radio display.

### 9.29.1 Automatic Encryption

For automatic encryption, a system administrator will select the Talk Group to be encrypted at the interface to the UAS. Once the Talk Groups have been selected and identified as secure, credentials for key generation are generated automatically by the system and provisioned to authorized users. This process requires that authorized users log-in to the network and be authenticated. Encryption keys require no manual handling and are never sent “in the clear” over any network interface or airlink.

1. Locate the Talk Group that has been encrypted at the system administrator level.
2. “Pls Login” appears in the display (unless the keypad was used to log-in).
3. Log-in normally by entering your User ID and Password.

If a user is engaged in a call on a Talk Group encrypted at the network administrator level, “Secure Call” will appear in the second line of the dwell display if the user is logged into that Talk Group.

If a secure call is in progress elsewhere and the user has not logged in, the bottom of the dwell display will alternate between “No Access” and the alias of the radio that is currently engaged in the secure call.



NOTE

If enabled via programming, a radio can automatically log-in at voice registration and enable voice encryption.

### 9.29.2 A/B Switch

If configured, the A/B switch can be used to enable or disable encryption.

### 9.29.3 Manual Encryption (System Model Only)

Two or more users can manually encrypt a call, if enabled, without an established encrypted Talk Group. A pre-determined “key or code” is required. While a user is engaged in a manually encrypted call, users within the Talk Group that are not encrypted can still make standard voice calls on that Talk Group. The encrypted user can hear the standard unencrypted calls, but cannot respond while still manually encrypted.

Manual key entry only affects the currently selected Talk Group. All available Talk Groups within the current profile may be independently encrypted.



The key must be pre-determined by the users prior to making a manually encrypted call on a Talk Group and is entered into the radio using the keypad. For 128-bit encryption, this key is between 1 and 16 digits. For 256-bit encryption, this key is between 17 and 32 digits.

### 9.29.3.1 Using Manual Encryption

1. Press \*32 on the keypad.
2. Enter the key (1 – 16 digits for 128-bit encryption; 17 – 32 digits for 256-bit encryption).
3. Press #.
4. To end manual encryption, press \*33.

If a user is engaged in a call on a Talk Group that has been manually encrypted at the radio level, the user will see “Secure Call” on the bottom of the dwell display.

If a secure (encrypted) call is in progress, and the user has not entered the key, the bottom of the dwell display will alternate between “No Access” and the alias of the radio that is currently engaged in the secure call.

Once the user has terminated manual encryption, “UnSecure” appears temporarily in the bottom line of the dwell display.

## 9.30 STATUS MESSAGES







If enabled via programming, the radio can transmit a pre-programmed status message. Section 8.30.1 describes how to send a status message via the keypad and Section 8.30.2 describes how to send a status message via the menu.



### 9.30.1 Send Status Message via the Keypad (System Model Radios Only)

1. Press \*2 <0...9> # on the keypad.
2. A Status message can be associated with each key (0 – 9). This text is displayed on the first line of the display when the key is pressed until another key is pressed.
  - If no messages have been configured, “No Messages” is displayed.
  - If a message is not assigned to a key, “No Entry” is displayed for the keypad sequence.
  - You can press multiple keys to select the desired Status message.
3. The # key terminates the keypad sequence and sends the currently selected status message. If no messages have been configured or no message is associated with the key, no message is sent and an error tone is played.

Press the \* key to cancel the keypad sequence.

### 9.30.2 Send Status Message via the Menu

1. Press  or  until "Status Msg" appears and press . If no messages have been configured, "No Messages" is displayed.
2. Scroll through the available messages using  or . The configured Status message is displayed on the 1<sup>st</sup> line of the display.
3. Press the  button to send the currently selected message. If no messages have been configured, no message is sent and an error tone sounds.

Press  or  to cancel status message selection.

## 9.31 REQUEST TO TALK (RTT) MESSAGES







If enabled via programming, the RTT message feature allows you to send a short service message to the VNIC. Section 8.31.1 describes how to send an RTT message via the keypad and Section 8.31.2 describes how to send an RTT message via the menu. Only one RTT message can be programmed into the radio.

### 9.31.1 Send RTT Message via the Keypad (System Model Radios Only)

1. Press \*5 <0...9> # on the keypad. The key associated with the RTT message (0-9) is configured via programming.
2. This message is displayed on the first line of the display when the key is pressed until another key is pressed.
  - If no message has been configured, "No Message" is displayed.
  - If a message is not assigned to the key, "No Entry" is displayed for the keypad sequence.
3. The # key terminates the keypad sequence and sends the currently selected RTT message. If no message has been configured or no message is associated with the key, no message is sent and an error tone is played.

Press the \* key to cancel the keypad sequence.

### 9.31.2 Send RTT Message via the Menu

1. Press  or  until "RTT Msg" appears and press . If no message has been configured, "No Message" is displayed.
2. Use  or  to select the message. The configured RTT message is displayed on the 1<sup>st</sup> line of the display.
3. Press the  button to send the selected message. If no message has been configured, no message is sent and an error tone sounds.

Press  or  to cancel RTT message selection.

## 9.32 SITE LOCK





Users may need to select the site in cases where network communications are down. The Site Lock menu allows a user to manually roam to a specific site. The sites in the menu are populated with the current site, adjacent sites, and node 2 sites. The menu allows the user to select a site based on the Site Name. Once selected, the radio will randomly pick a channel at the site that is identified as operational and attempt to attach to it.

If the channel is not available, the radio attempts to attach to the next channel in the channel list for the site until it has attempted every channel at the site. If no channels are available, the radio plays a “Site Not Found” tone and displays “SiteUnavail” on the second line of the Site Lock menu. The radio reverts to its normal roaming functionality.

If the radio does find a valid channel on the site, it attaches to it, plays a “Site Found” tone, displays “SiteAvail” on the second line of the Site Lock menu for 2 seconds, and then reverts to the Dwell menu.

### 9.33 GPS COORDINATES

The radio’s current latitude and longitude coordinates may be displayed using the “GPS” menu. The following procedure assumes a GPS antenna is connected to the radio and it is receiving adequate signals from GPS satellites.

1. Press  or  until the “GPS” menu appears in the display. Current GPS coordinate latitude and longitude data continuously scrolls in the top line of the display in a degrees:minutes:seconds format.
2. Press  or  to change to another menu.



NOTE

If the internal GPS receiver’s data is expired (30 minutes or more) or unavailable, the radio uses the serving base station’s coordinates [GPS (Site) is displayed]. The GPS Menu will also indicate if the data is aged (2 minutes or more) [GPS (Aged) is displayed].

### 9.34 USING THE GPS SPEAKER MIC

1. Go outside of a building. Turn the radio on.
2. Press the  button.
3. Scroll through the menu until “GPS (SITE)” is displayed.
4. The latitude and longitude of the site scrolls by in degrees, minutes, seconds.
5. When the display goes from “GPS (SITE)” to “GPS,” the GPS speaker/mic has acquired synchronization with the satellites, and the user’s present position is shown.

### 9.35 V-TAC OPERATION

#### 9.35.1 Extended Coverage Modes (XCOV, XCOV-TG, and XCOV-PROF)

In addition to all standard portable radio operating capabilities, Extended Coverage adds the V-TAC’s bridging (vehicular repeat) functionality for accessing the OpenSky radio network. Each portable radio connected to the V-TAC using Extended Coverage is considered a “client” on the V-TAC. Extended Coverage benefits portable radio users since it allows them to get network connectivity using the V-TAC’s higher transmit output power and better antenna system.

The V-TAC supports three Extended Coverage modes: Extended Coverage for individual users (XCOV), Extended Coverage for a Talk Group (XCOV-TG), and Profile Extended Coverage (XCOV-PROF). Typically, Extended Coverage is used after the vehicle’s operator has exited the vehicle with a portable radio unit and the portable unit requires this bridging functionality to access the OpenSky radio network.

The V-TAC takes advantage of OpenSky's TDMA capability to eliminate interference between its local and network radio links when operating in an Extended Coverage mode, an undesirable characteristic of many traditional vehicular repeater systems. Because the V-TAC employs this technology, interference on the network and local radio links is minimized.

A V-TAC in Extended Coverage mode sends its alias to clients. The alias is displayed in the second line of the dwell menu of the client, ("VA <alias>"). The client must be connected to a V-TAC running version OTP14.4 or later for the V-TAC to provide the alias to the client. If the client is connected to a V-TAC running version OTP14.3.1 or earlier, the client displays "VA None."

### **9.35.2 Change Between Extended Coverage Modes**

By default, the specific Extended Coverage mode utilized is determined by settings programmed into the V-TAC and portable radios from the system administrator or radio installation personnel. These programmed settings determine which Extended Coverage mode the V-TAC and radios normally use and determine the access method employed by a portable radio to connect to the V-TAC. After these settings are programmed to the V-TAC and portable radios, each must be rebooted (powered off and then back on) before the change takes effect.

See the following sections for instructions on how to override this setting manually. The override is only successful if the V-TAC operating mode matches the manually selected portable V-TAC mode.

### **9.35.3 Radio Limitations Using Extended Coverage Modes**

Connecting a portable radio to a V-TAC introduces minor functional limitations. See the following sections for a listing.

#### **9.35.3.1 Limitations Using XCOV, XCOV-TG, and XCOV-PROF**

Portable radios connected to the V-TAC using any of the Extended Coverage Modes, XCOV, XCOV-TG, or XCOV-PROF, will not channel-scan unless they lose radio frequency contact with the V-TAC. If manually enabled, radios will not scan network channels.

#### **9.35.3.2 Limitations Using XCOV-TG**

The following portable radio keypad functions are disabled when the radio is connected to the V-TAC using the XCOV-TG mode: log-off, manual log-in, alerts, selective calls, PSTN calls, and speed dial calls, SOI mode, RTT.

The following portable radio menus are disabled when the radio is connected to the V-TAC using the XCOV-TG mode: alert destination, alert message, alert received, channel, speed dial, priority 1 Talk Group, priority 2 Talk Group, priority 3 Talk Group, RTT, Status message, site lock and scan mode. In addition, the user cannot change Talk Group or profile.

#### **9.35.3.3 Limitations Using XCOV-PROF**

The following portable radio keypad functions are disabled when the radio is connected to the V-TAC using the XCOV-PROF mode: log-off, manual log-in, alerts, selective calls, PSTN calls, and speed dial calls, SOI mode, RTT.

The following portable radio menus are disabled when the radio is connected to the V-TAC using the XCOV-TG mode: alert destination, alert message, alert received, priority 1 Talk Group, priority 2 Talk Group, priority 3 Talk Group and scan mode. In addition, the user cannot change Talk Group or profile.

### **9.35.4 Use XCOV Mode**

The Extended Coverage for individual users (XCOV) mode allows up to eight (8) client radios to connect to the V-TAC. The radios have full radio functionality including selective calling and mobile data.





With the Extended Coverage for individual users' (XCOV) mode, V-TAC configuration defines which portable radios are permitted V-TAC access. The radio will automatically connect to a V-TAC if it cannot find a network channel. The radio can also be manually connected to a V-TAC as indicated with the \*61# and \*62# commands, each determined by the system administrator in the radio configuration.

#### **9.35.4.1 Manually Accessing the XCOV Mode**

##### **System Model Radios**

1. Press \*61# to manually access XCOV mode.
2. Press \*60# to manually disconnect from XCOV mode.

##### **Both Model Radios**

1. Press  or  until the Client Mode menu appears.
2. Press  or  until XCOV is displayed.
3. Press  to confirm mode selection. The radio reverts to the dwell display and the V-TAC icon is displayed.

### **9.35.5 Use XCOV-TG Mode**

When using the XCOV-TG mode, up to thirty (30) client radios can connect to the V-TAC. However, unlike XCOV, radios connected using XCOV-TG are limited to communicating only on the XCOV-TG Talk Group. The radio can only raise an emergency if this Talk Group is emergency capable. Advanced features such as selective calling and mobile data operations are not available to the XCOV-TG connected clients. The radio will automatically connect to a V-TAC if it cannot find a network channel.

The Talk Group used for XCOV-TG communications is the Talk Group that was selected at the V-TAC when it entered XCOV-TG mode. Before a radio can connect to the V-TAC, the Talk Group must be selected on the radio. If this Talk Group is not provisioned in the radio's personality, the radio cannot connect to the V-TAC via the XCOV-TG mode. While connected to the V-TAC via XCOV-TG, a different Talk Group or profile cannot be selected.

When a portable radio is connected to the V-TAC via XCOV-TG, the V-TAC forwards only the network voice traffic on the XCOV-TG Talk Groups.

#### **9.35.5.1 Manually Accessing the XCOV-TG Mode**

For the Extended Coverage for a Talk Group mode (XCOV-TG), a portable radio user is granted access and connects to the V-TAC by simply selecting the same Talk Group that the V-TAC had selected when it entered the XCOV-TG mode. Contact the system administrator for questions regarding these aspects.





During XCOV-TG mode operations, the V-TAC will not disconnect portable radios connected to it. A portable radio user must manually disconnect from the V-TAC by pressing \*60 # on the radio's keypad.

However, if the V-TAC is switched out of the XCOV-TG mode, all portable radios will be automatically disconnected from the V-TAC. The radios will continue to look for another V-TAC until manually disconnected (\*60#).

### **System Model Radios**

- Press \*62# to manually access XCOV-TG mode.
- Press \*60# to manually disconnect XCOV-TG mode.

### **Both Model Radios**

1. Press  or  until the Client Mode menu appears.
2. Press  or  until XCOV-TG is displayed.
3. Press  to confirm mode selection. The radio reverts to the dwell display and the V-TAC icon is displayed.

## **9.35.6 Using XCOV-PROF Mode**

In XCOV-PROF mode, client attachment to a V-TAC is based on profile rather than Talk Group. XCOV-PROF mode allows the transmission and receipt of voice calls on any Talk Group in the profile as opposed to only one Talk Group. XCOV-PROF allows emergencies on a non-selected Talk Group based on the emergency behaviors of the profile. XCOV-PROF minimizes data traffic between the client and V-TAC while allowing flexibility of voice functionality. As a result, data services between the client and V-TAC are disabled. The radio will automatically connect to a V-TAC if it cannot find a network channel.

Note the following regarding XCOV-PROF mode:





- The client profile must match the V-TAC.
- The client profile used to connect to the V-TAC must have been previously provisioned to the client prior to connection. If the profile is not in the client's personality, the client cannot connect to the V-TAC.
- Neither the V-TAC nor a client can change the profile once it has entered XCOV-PROF mode. The Profile menu will be disabled.
- Client global profiles are disabled.

### **9.35.6.1 Access XCOV-PROF Mode**

#### **System Model Radios Only:**

- Enter the command \*63# to set the radio to use the XCOV-PROF mode.
- Press \*60# to disconnect from the XCOV-PROF mode.

#### **Both Model Radios:**

1. Press  or  until the Client Mode menu appears.
2. Press  or  until XCOV-PROF is displayed.
3. Press  to confirm mode selection. The radio reverts to the dwell display and the V-TAC icon is displayed.

### 9.35.7 Use Scene-of-Incident Mode

The Scene-of-Incident mode (SOI) is user-selectable. The SOI mode provides a local repeater function (V-TAC) with no network connection.



When operating in the SOI mode, the radio is disconnected from the OpenSky network. Therefore, communications with radios and dispatch personnel on the network is not possible.

#### **SOI Mode, Manual Channel Entry (System Model Only)**

1. Press \*4#.
2. The radio prompts for the channel. Enter the channel number and press  to confirm channel.
3. The radio prompts for the band. Table 9-12 lists valid bands and their definitions. Enter the number assigned for the desired frequency band and press  to confirm.
4. The radio reverts to the dwell display. If accepted, you will be switched off the network, and be communicating locally through the V-TAC.

Press \*40# or use the Client Mode menu to return to normal operation (Network Mode). The personality and profile in use at the time the radio entered SOI mode is restored.

#### **SOI Mode, Manual Channel Entry (Both Model Radios)**

1. Press  or  until the Client Mode menu appears.
2. Press  or  until SOI is displayed.
3. Press  to confirm mode selection.
4. Press  or  until "Manual Select Chan" is displayed and press .
5. Press  or  to edit the right-most digit and press  to advance to the next digit. Repeat until the desired channel is entered.
6. The radio then prompts the user to edit the band. Table 9-12 lists valid bands and their definitions. Press  or  to edit the number assigned to the frequency band and press  to confirm and enter the SOI mode.

Use the Client Mode menu to return to normal operation (Network Mode). The personality and profile in use at the time the radio entered SOI mode is restored.

#### **SOI Mode, Pre-Programmed Channel Selection (Both Model Radios)**

1. Press  or  until the Client Mode menu appears.
2. Press  or  until SOI is displayed.
3. Press  to confirm mode selection.
4. Press  or  scroll through a list of pre-programmed channels.
5. Press  to confirm channel and enter SOI mode.

Use the Client Mode menu to return to normal operation (Network Mode). The personality and profile in use at the time the radio entered SOI mode is restored.



Table 9-12: Band Definitions

RF BAND	RF CHANNEL NUMBER
0 = SMR	Band 0: 1-830
1 = AMPS	Band 1: 1-600
2 = BORDER	Band 2: 1-600
3 = 700 MHz Band 1	Band 3: 1-477
4 = 700 MHz Band 2	Band 4: 481-957
5 = 700 MHz Band 3	Band 5: 1-477
6 = 700 MHz Band 4	Band 6: 481-957
7 = 900 MHz	Band 7: 1-399
8 = 800 MHz Rebanded	Band 8: 1-830
9 = 400 MHz T band WB	Band 9: 1-6718 (Independent Separation Between TX and RX)
10 = 400 MHz T band NB	Band 10: 1-6718 (Independent Separation Between TX and RX)
11 = 400 MHz T band Temp (NYPD only)	Band 11: 1-120
14 = 700 MHz reband WB	Band 14: 1-957
15 = 700 MHz reband NB	Band 15: 1-959

## 10. EDACS, CONVENTIONAL, AND P25 OPERATION

### 10.1 TURNING ON THE RADIO

1. Power ON the radio by rotating the POWER ON-OFF/VOLUME knob clockwise. A short alert signal (if enabled through programming) indicates the radio is ready to use.



NOTE

The radio can be programmed to require the entry of a PIN to operate the radio. Check with your System Administrator if you forget your PIN. As the PIN is entered, an asterisk is displayed for each digit. The actual value is not displayed.

2. The display shows the last selected system and group or a default system and group (depending on programming).
3. Adjust the POWER ON-OFF/VOLUME knob to the desired volume level.
4. Select the desired system and group. The display indicates the current system and group names.
5. The radio is now ready to transmit and receive calls.



NOTE

In the trunked environment, CC SCAN will be displayed if communication with the system's control channel cannot be established. This may occur if, for example, the radio is out of range of the trunking site. It may be necessary to move to another location or select another trunking system to re-establish the control channel link for trunked mode operations. CC SCAN is displayed on the group line until a control channel is accessed. The length of time before the radio enters CC Scan after losing communication with the Control Channel is configurable in RPM.

## 10.2 CONTROLS

The XG-75P portable radios feature two rotary control knobs, an emergency button, and an A/B switch located on the top of the radio (Figure 10-1). The Push-To-Talk (PTT) button and two option buttons are located on the side (Figure 10-2) of the radio. The front mounted keypad of the System model has 15 buttons and the Scan model has six buttons. Refer to Figure 10-3 and Figure 10-4, respectively.

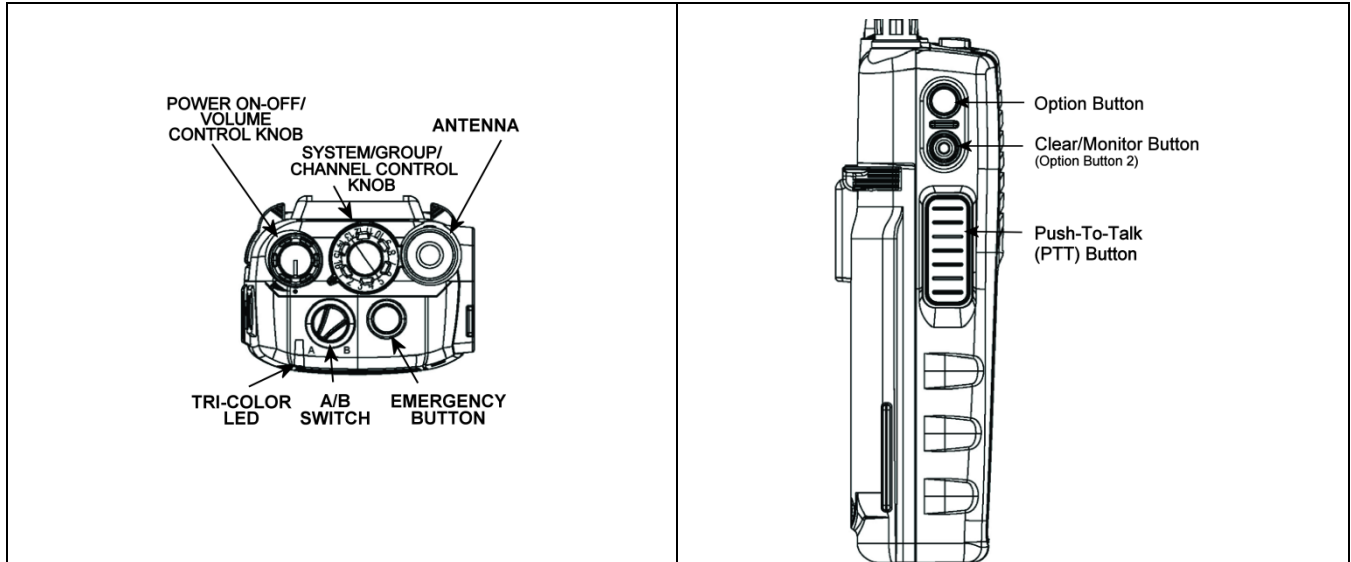

Figure 10-1: Top View

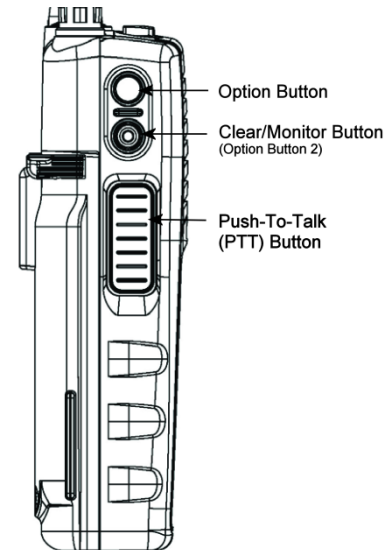



Figure 10-2: Side View

### 10.2.1 Buttons, Knobs, and Switch

The functions of the buttons and knob controls vary depending on mode of operation and radio programming. The A/B is currently software defined only in ECP mode. Default functions of the button, switch, and knob controls are discussed in general terms in Table 10-1.

**Table 10-1: Buttons, Knobs, and Switch Functions**

<p><b>POWER ON/OFF-VOLUME CONTROL KNOB</b></p>	<p>Applies power to the radio and adjusts audio volume.</p> <div style="border: 1px solid black; padding: 5px; margin: 10px 0;">  <p><b>NOTE</b></p> <p>The radio can be programmed to require the entry of a PIN to operate the radio. Check with your System Administrator if you forget your PIN. As the PIN is entered, an asterisk is displayed for each digit. The actual value is not displayed.</p> </div> <p>Rotating the control clockwise applies power to the radio. If enabled through programming, a single alert tone indicates the radio is operational.</p> <p>Rotating the control clockwise increases the volume level. A minimum volume level can be programmed into the radio to prevent missed calls due to a low volume setting. While adjusting the volume, the display momentarily indicates the volume level (i.e., <b>VOL=31</b>). The volume ranges from a minimum programmable level of zero (displayed as <b>OFF</b> in the display) up to 40, which is the loudest level.</p>
<p><b>SYSTEM/GROUP/CHANNEL CONTROL KNOB</b></p>	<p>Used to select groups/channels. This is a 16-position rotary knob.</p>
<p><b>EMERGENCY/HOME BUTTON</b></p>	<p>Automatically selects a pre-programmed “Home” Group/System by pressing and holding for a programmed duration OR it can be used to declare an emergency by pressing and holding for a programmed duration. The button can be pre-programmed for either operation, but not both.</p>
<p><b>PUSH-TO-TALK (PTT) BUTTON</b></p>	<p>The PTT button is pressed before voice transmission begins.</p>
<p style="text-align: center;">○</p>	<p>Activates a programmable software option selected during PC programming.</p>
<p style="text-align: center;">⊙</p>	<p>Exits the current operation (removing all displays associated with it) and returns the radio to the selected Talk Group.</p> <p>In conventional mode: allows the user to monitor the channel for activity.</p>
<p><b>A/B SWITCH</b></p>	<p>The function of the A/B switch is user-defined from a list of programmable options.</p>

## 10.2.2 Keypad

The front mounted keypad of the Scan model has six buttons and System model has 15 buttons. Refer to Figure 10-3 and Figure 10-4, respectively.

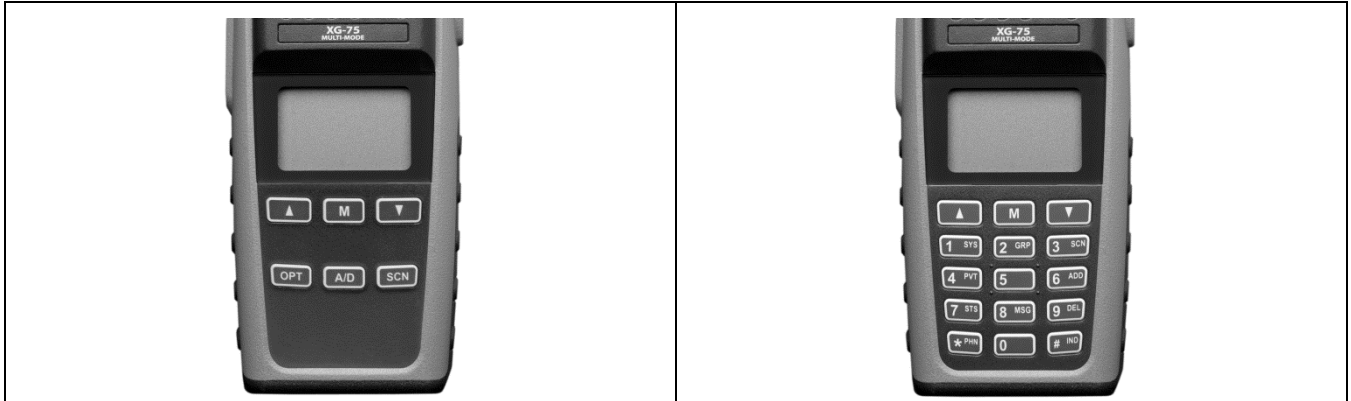

Figure 10-3: Scan Model Front Panel



Figure 10-4: System Model Front Panel

The primary and secondary functions of each key, where applicable, are described in Table 10-2.

Table 10-2: XG-75P Front Keypad Functions

KEY	FUNCTION
	<u>Primary Function:</u> Accesses the menu. <u>Secondary Function:</u> Activates a selected item within the menu, similar to an “Enter” key.
	<u>Primary Function:</u> Scrolls through available systems, groups, or channels, depending on personality programming. <u>Secondary Function:</u> Changes the selection for an item within a list.
	Adds/deletes selected groups or channels from the scan list of the currently selected system.
	Toggles scan operation on and off.
	Activates one of any programmable software options selected during radio programming, i.e., high/low TX power and talkaround.
	<u>Primary function:</u> Selects a specific system. If the rotary knob is used to select the system and more than 16 systems are programmed in the radio, the  key is used to select additional banks (groupings) of systems.
	<u>Primary function:</u> Selects a specific group.
	<u>Primary function:</u> Turns the Scan operation on and off.
	<u>Primary function:</u> Enables or disables encryption for the system/group/channel displayed.
	<u>Primary function:</u> Adds groups or channels from the currently selected system to the scan list.

KEY	FUNCTION
7 STS	<u>Primary function:</u> The Status key accesses the status list (0-9) permitting the transmission of a pre-programmed status message to an EDACS or P25 site.
8 MSG	<u>Primary function:</u> The Message key accesses the message list (0-9). The Message key permits the transmission of a pre-programmed message to an EDACS or P25 site.
9 DEL	<u>Primary function:</u> Deletes selected groups or channels of the currently selected system from the Scan list.
0	<u>Primary function:</u> Inverts display – Toggle normal/invert. Requires ECP R16B or later.
1 SYS 2 GRP 3 SCN 4 PVT 5 6 ADD 7 STS 8 MSG 9 DEL 0 * PIN # IND	<u>Secondary function:</u> The secondary function of these keys acts as a typical DTMF telephone pad, and are used to place telephone interconnect and individual (unit-to-unit) calls.
* PIN	<u>Primary function:</u> In EDACS and P25 modes, initiates telephone interconnect calls.
# IND	<u>Primary function:</u> In EDACS and P25 modes, initiates individual, unit-to-unit calls.

### 10.3 DISPLAY

The XG-75P display is made up of four lines, each containing twelve alpha-numeric character blocks. If programmed, the display backlighting will illuminate upon power-up or when radio controls are operated. Specific display characteristics will be discussed in following sub-sections.

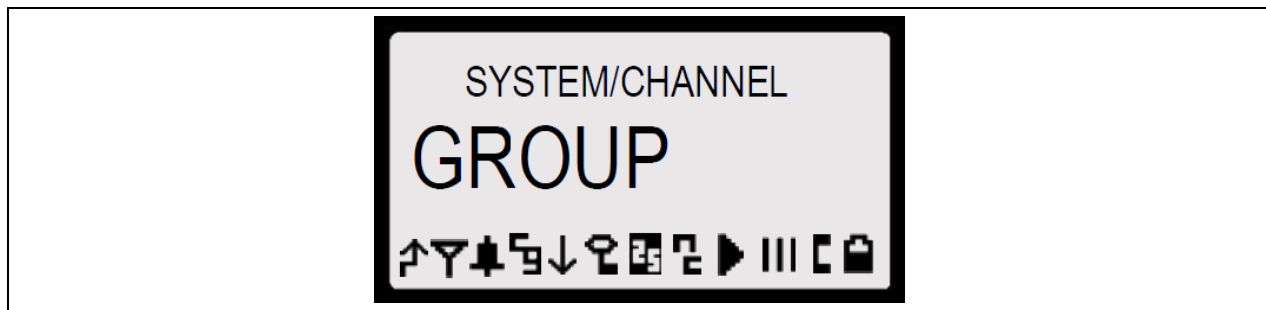

















Figure 10-5: XG-75P Radio Display

Table 10-3 describes the icons that may be displayed by the XG-75P during operation.

Table 10-3: Status Icons Descriptions

ICON	DESCRIPTIONS
↑	<b>Steady</b> – during all radio transmissions.
⏏	<b>Steady</b> – “Busy” transmitting or receiving, call queued.
🔊	<b>Steady</b> – T99 Mode enabled.

ICON	DESCRIPTIONS
	<b>Steady</b> – Channel Guard enabled. <b>If icon is not visible</b> – Channel Guard is disabled.
	<b>Steady</b> – EDACS system in Failsoft™ mode.
	<b>Steady</b> – transmit at low power. <b>If icon is not visible</b> – transmit at high power.
	<b>Steady</b> – transmit in encrypt mode. <b>Flashing</b> – receiving an encrypted call.
	<b>Steady</b> – Indicates the current channel is set up as a Project 25 (P25) channel.
	<b>Steady</b> – Indicates the current channel is set up as a ProVoice channel.
	<b>Steady</b> – Indicates the current channel is set up as an analog channel.
	<b>Animated (rotates clockwise)</b> – scan mode enabled. <b>If icon is not visible</b> – scan is disabled.
	<b>Steady</b> – priority 1 group or channel.
	<b>Steady</b> – priority 2 group or channel.
	<b>Steady</b> – group or channel in scan list.
	<b>Steady</b> – special call mode (individual or telephone).
	<b>Steady</b> – battery charge indicator. The battery charge indicators illustrate approximate level only, based on battery voltage.
	<b>Flashing</b> – Low battery indicator.
	<b>Steady</b> – Noise cancelling is enabled.
	<b>Flashing</b> - Acquiring GPS satellites. <b>Steady</b> - GPS satellites have been acquired.

## 10.4 TRI-COLOR LED

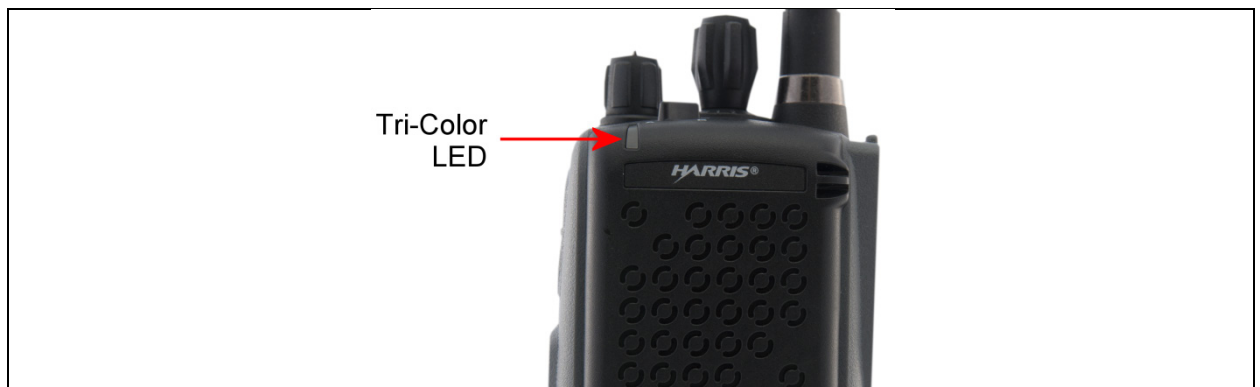

Figure 10-6: Tri-Color LED

The Tri-Color LED changes color to indicate radio status and is visible from both the front and top of the radio (see Figure 10-1). In addition, the mode of operation may also help determine what the color of the LED represents.

- Green:** Receiving
- Red:** Transmitting Unencrypted
- Orange:** Transmitting Encrypted

## 10.5 UNIVERSAL DEVICE CONNECTOR

The Universal Device Connector (UDC) provides connections for external accessories such as a headset, a speaker-microphone, audio test box, audio test cables, and programming cables. The UDC is located on the right side of the radio, opposite the PTT Button. The UDC facilitates programming and testing the radio. The UDC pins perform different functions depending on the accessory attached to the UDC.

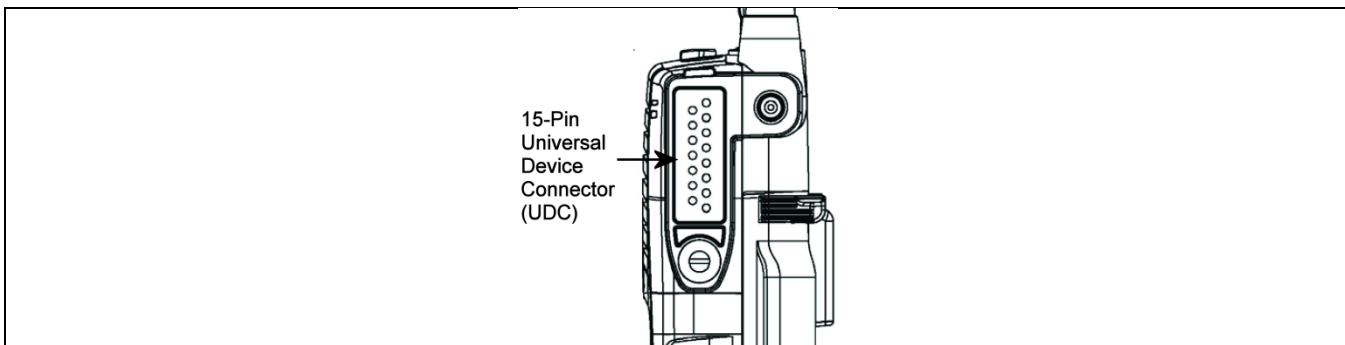

Figure 10-7: XG-75P 15-Pin Universal Device Connector

## 10.6 NOISE CANCELLATION

The XG-75P features L3Harris' proprietary noise suppression capability to provide clear and crisp voice quality in high-noise environments for use in any mode, including both analog and digital communications.

The XG-75P has two microphones; one located on the front (primary) and one on the rear (secondary). The primary microphone operates in the same manner as a normal radio and is the one you talk into. The secondary microphone is used to pick up the surrounding noise when noise cancellation is turned on.

In the case where noise cancellation is enabled and a speaker microphone is attached to the XG-75P, talk into the speaker microphone. In this mode, XG-75P front microphone is used to pick up the surrounding noise, and the rear microphone is unused.

If the secondary microphone is blocked, the XG-75P operates as though noise cancellation is turned off.

### 10.6.1 Turning Noise Cancellation On and Off

A button on the radio or the A/B switch can be programmed to toggle noise cancellation on or off.

**OR**

1. Press the  button.
2. Use the  or  button to select "NOIS CAN."



3. Press the **M** again to toggle noise cancellation on or off.

The top line of the display will briefly display “NC ON” or “NC OFF.” When noise cancellation is enabled, the **NC** icon is displayed on the bottom of the display.

### 10.6.2 Using Noise Cancellation

When using the noise cancellation feature, observe the following:

- Talk within two (2) inches of primary microphone (see Figure 10-8).
- Speak clearly, loudly, and with authority.
- If possible, face the noise source when talking into the radio (see Figure 10-8).
- Ensure the primary and secondary microphones are not covered. See Section 10.6.4 for more information on the primary and secondary microphones.
- In very noisy environments, it is okay to yell into the radio. The radio can handle very loud input levels.

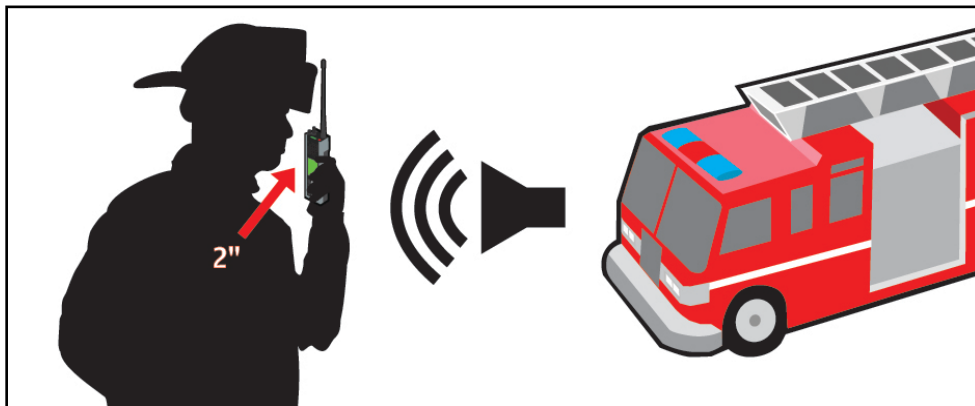

Figure 10-8: Using the Noise Cancellation Feature

### 10.6.3 The Effect of Distance from the Microphone

Unlike a normal microphone system, noise cancellation makes the level of your voice diminish quickly as you move away from the radio. In essence, the radio starts to see your voice as surrounding noise. Whereas, you may be comfortable speaking up to a foot away from the front of a normal radio, noise cancellation requires that you keep it close.

### 10.6.4 Primary versus Secondary Microphone

#### 10.6.4.1 Without a Speaker Microphone Attached

The primary microphone is located on the front of the radio and the secondary is on the back of the radio.

#### 10.6.4.2 With a Speaker Microphone Attached

When a speaker microphone is attached, the radio electronically switches over to use the radio's front microphone as secondary. The microphone on the attached speaker microphone becomes the primary microphone.

## 10.7 STATUS MESSAGES (EDACS AND P25 TRUNKED)

During radio operation, various radio Status Messages may be displayed. The messages are described below.

<b>MESSAGE</b>	<b>NAME</b>	<b>DESCRIPTION</b>
<b>QUEUED</b>	Call Queued	Indicates the system has placed the call in a request queue.
<b>SYS BUSY</b>	System Busy	Indicates the system is busy, no channels are currently available, the queue is full, or an individual call is being attempted to a radio that is currently transmitting.
<b>DENIED</b>	Call Denied	Indicates the radio or talkgroup is not authorized to operate on the selected system or talkgroup.
<b>CC SCAN</b>	Control Channel Scan	Indicates the control channel is lost and the radio has entered the Control Channel Scan mode to search for the control channel. This is usually an out of range indication.
<b>WA SCAN</b>	Wide Area Scan	Indicates the radio has entered the Wide Area Scan mode to search for a new system. Wide Area Scan mode must be enabled through programming.
<b>SYSC ON</b>	System Scan Features On	Indicates the System Scan features are enabled.
<b>SYSC OFF</b>	System Scan Features Off	Indicates the System Scan features are disabled.
<b>LOW BATT</b>	Low Battery	Battery voltage has dropped to the point to where the radio is no longer able to transmit. The radio will still receive calls until the battery is discharged beyond the point of operation, at which time the radio automatically shuts down.
<b>RXEMER</b>	Receive Emergency	Indicates an emergency call is being received. This message flashes on line two.
<b>TXEMER</b>	Transmit Emergency	Indicates an emergency call has been transmitted on this radio. This message will be flashing on line two.
<b>VOL=31</b>	Volume Level	Indicates the current volume level. The volume level display ranges from <b>OFF</b> (muted) to <b>40</b> (loudest).
<b>WHC</b>	Who Has Called	Indicates an individual call has been received, but not responded to. The indicator turns off if the individual call mode is entered, the system is changed, or the radio is turned off and then on again.
<b>UNKNOWN</b>	Unknown ID	Indicates an individual call is being received from an unknown ID.

## 10.8 ERROR MESSAGES

If either of the Error Messages shown below is displayed, the radio is programmed incorrectly or needs servicing.

**DSP ERR**                      or    **DIG V**  
**ERR=XXXX**                      **ERR**  
 (Power-up only)

Where **xxxx** is the error code and **DSP ERR** or **DIG V ERR** is the message.

## 10.9 ALERT TONES

The XG-75P radio provides audible Alert Tones or “beeps” to indicate the various operating conditions (see Table 10-4).

**Table 10-4: Alert Tones**

NAME	STONE	DESCRIPTION
Call Originate	one short mid-pitched	OK to talk after pressing the push-to-talk button.
Call Queued	one high-pitched	Call queued for processing.
Autokey	one mid-pitched	Queued call received channel assignment.
System Busy	three low-pitched	System busy or unable to complete call.
Call Denied	one low-pitched	Radio is not authorized on the system or group.
Carrier Control Timer	five high-pitched/one long low-pitched	PTT depressed for maximum length of time.
Low Battery	one low-pitched/one short mid-pitched	Low battery.
TX Low Battery Alert	one low-pitched	After PTT - battery too low to transmit.

## 10.10 VOICE ANNUNCIATION





When enabled via programming, the Voice Annunciation feature provides audible feedback for various radio operations. The radio can be programmed to play an audio message for any or all of the following. This message can be a pre-recorded (canned) message or a user-recorded message.



- Channel changes
- System changes
- Encryption On/Off
- Noise Cancellation On/Off
- Scan On/Off
- Talkaround On/Off

For more information on configuring the radio for Voice Annunciation, refer to the Voice Annunciation Feature manual, 14221-7200-6110.



## 10.11 SYSTEM/ZONE SELECTION

**METHOD 1:** From the control knob: If system/zone selection is programmed to the System/Group/Channel control knob, select a system/zone by turning the knob to the desired system/zone number position (1-16). The display registers the new system/zone name on line one. The  button can be programmed to provide access to a “2<sup>nd</sup> bank” of 16 system/zone number positions (17-32).

**METHOD 2:** From the keypad: If system/zone selection is programmed as the primary function of  and , select a system/zone by pressing  or  to scroll through the system list. The display registers the new system/zone name on line one.



METHOD 3: **(System model radios only)** Direct Access: Press  to enter the system select mode. Press the numeric key, which is mapped to the desired system/zone. Press . The radio will move to the selected system/zone.



If system selection is programmed to the System/Group/Channel control knob, direct access to systems will not be available. Pressing  or  will scroll through different sets of 16 systems each (banks) if more than 16 systems are programmed into the radio. The systems within each bank are then selectable via the System/Group/Channel control knob as described previously in METHOD 1.

Example:





System:     1 = North  
               2 = South  
               3 = East  
               4 = West



1. Press . (South is the currently selected system.)
2. Press . (Press 4 to select "West" system.)
3. Press . (West is the newly selected system.)

## 10.12 GROUP/CHANNEL SELECTION

Several methods can be used to select a new group or channel.

METHOD 1: From the Control knob: If group selection is programmed to the System/Group/Channel control knob, select a group by turning the System/Group/Channel control knob to the desired group number position. The display registers the new group name on line two. If the knob is moved to a position greater than the number of programmed groups, the highest programmed group will remain selected. The  button can be programmed to provide access to a "2<sup>nd</sup> bank" of 16 group number positions (17-32).

METHOD 2: From keypad: If group selection is programmed as the primary function of  and  select a group by pressing  or  to scroll through the group list. The display registers the new group name on line two.

METHOD 3: **(System model radios only)** Direct Access: Press  to enter the group select mode. Press the numeric key mapped to the desired group. Press . The radio will move to the selected group.

In trunked mode, press PTT button and speak normally while holding the microphone approximately two inches from your mouth.

In conventional mode, press the Monitor/Clear button briefly. If audio is heard or  is illuminated, then the channel is busy. Wait till the channel become available and press the PTT button and speak normally while holding the microphone approximately two inches from your mouth.

## 10.13 MODIFY SCAN LIST

### 10.13.1 System Model Radio

1. Press **[3 SCN]** to toggle scan off and verify  is **not** displayed.
2. Select group or channel.
3. Press **[9 DEL]** once to remove group or channel from list.
4. Press **[6 ADD]** once to add as a normal group or channel.
5. Press **[6 ADD]** twice to add as a Priority 2 group.
6. Press **[6 ADD]** three times to add as a Priority 1 group.
7. Press **[3 SCN]** to re-start scanning.

### 10.13.2 Scan Model Radio

1. Press **[SCN]** to toggle scan off and verify  is **not** displayed.
2. Select group or channel.
3. Press **[A/D]** once to remove group or channel from the list.
4. Press **[A/D]** once to add as a normal group or channel.
5. Press **[A/D]** twice to add as a Priority 2 group.
6. Press **[A/D]** three times to add as a Priority 1 group.
7. Press **[SCN]** to re-start scanning.

## 10.14 MENU

The Menu function accesses features that are not available directly from the keypad. The menu items available and the order of menu items is configurable through programming. Upon radio power-up, the menu item that is at the top of the menu list will always be displayed first. Subsequent access to the menu function will return the last menu item that was shown in the display and cursor position.

1. To enter the menu mode, press **[M]**.
2. Upon entering the menu selection mode, menu options will appear in the display (see Figure 10-9).

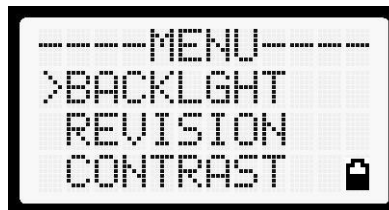

**Figure 10-9: Menu Display**

3. The radio will continue to receive and transmit normally while in the menu.
4. Use the **[▼]** or **[▲]** keys to scroll through the menu options.

5. Align the > with the desired menu option and press **M** to select it. The menu item's parameter setting shown in the display can be changed using **▼** or **▲** to scroll through the list of parameter values.
6. Once the desired setting is reached, press **M** to store the value and return to the main display.

For menu items that display radio information, pressing **▼** or **▲** will scroll through a list of informational displays. Possible menu items are listed in Table 10-5.

### 10.14.1 Menu Item Selection Process

An example of the backlight menu item selection process and menu item parameter change is shown in Figure 10-10.

1. Press **M**. The menu mode is entered.
2. Press **▼** or **▲** until the display shows:

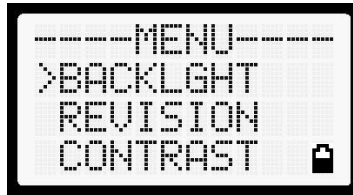

**Figure 10-10: Backlight Menu Item Selection Parameter**

3. Press **M**. The backlight menu item is activated. Line one shows the active menu item and its current parameter setting. Line two shows the currently selected system or group name (see Figure 10-11).

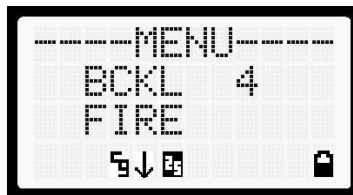

**Figure 10-11: Backlight Menu Display**

4. The menu item's parameter setting shown in the display can now be changed by using **▼** or **▲**.
5. Once the desired setting is reached, press **M** to store the value and return the menu option selection level.

For menu items that display radio information, pressing **▼** or **▲** will scroll through a list of informational displays. An example of information displays is shown in Table 10-5.



The TX POWER menu item, when selected, toggles LOW/HIGH power. It does not use **▼** or **▲** to scroll nor is an additional press of the **M** button required.







Table 10-5: Menu Item Information

FEATURE	DISPLAY	PARAMETER SETTING	COMMENT
Keypad Lock	KEY LOCK	Locked Unlocked	Locks the keypad. To unlock; press and release <input type="checkbox"/> M then within 1 second press the <input type="radio"/> button. This sequence is also a short cut to locking the keypad.
Backlight Adjust	BACKLGHT	OFF, 1 thru 6	Selects the light level for backlighting.
Contrast Adjust	CONTRAST	1, 2, 3, 4	Selects the display contrast level.
Transmit Power Select	TX POWER	HIGH or LOW	Selects radio output power mode.
Radio Revision Information	REVISION	N/A	Selects the information display to view. <i>Informational display only (see Table 10-6). No user selectable settings.</i>
Toggle Scan On/Off	SCAN	ON/OFF	Toggles Scan operation ON/OFF.
Toggle Private Mode	PRIVATE	ON/OFF	Toggles Private Mode ON/OFF.
Display Current Encryption Key	DISP KEY	N/A	Displays current encryption key. Informational display only. <i>No selectable settings.</i>
Display Current Home Group/Channel	HOME	N/A	Selects Home Group/Channel.
Select Desired System	SYS SEL	N/A	Selects a new system.
Add Group/Channel to Scan List	SCAN ADD	N/A	Adds to Scan List.
Delete Group/Channel	SCAN DEL	N/A	Deletes Group or Channel from Scan List.
Add/Delete Scan List	SCAN A/D	N/A	Add or Delete from Scan List.
Select Telephone Numbers From Phone List	PHN CALL	N/A	Trunked Only.
Data Operation	NO DATA	ON/OFF	Trunked Only. Toggles Data Operation ON/OFF.
Select Individual Call from IC List	IND CALL	N/A	
Select Group	GRP SEL	N/A	
Feature Encryption Display	FEATURES	N/A	Indicates current features programmed into the radio as well as certain information required to add features to the radio. <i>Informational display only. No user selectable settings.</i>
System Scan Enable	SYS SCAN	ON/OFF	Toggles System Scan feature ON/OFF.
Display GPS information	GPS	N/A	Displays GPS Status (On/Off), Latitude, Longitude, Speed/Direction, and time.
Select Mixed System/Zone	ZONE	N/A	Select a Mixed System Zone.
Display Caller ID	CALL ID	N/A	Displays the Radio IDs or alias names for the last 10 received calls.
View/Modify Custom Scan List	Menu Item: <b>CUSTSCAN</b>		Allows you to view and edit a Custom Scan list.







Table 10-6: Information Display

RADIO ID XXXXXXXX	LID in EDACS IP. In Conventional, it has no meaning.
RAM SIZ	RAM Size
FLSH SIZ	Flash Size
RF BAND	Frequency Band
PERS VER	Software Version
DSP DATE	Date DSP code was built.
DSP TIME	Time DSP code was built.
DSP FEAT	The DSP Features supported by the DSP code, in Hexadecimal. Bit mapped (see IPC spec for details): <ul style="list-style-type: none"> <li>• 0x0001 – Conventional</li> <li>• 0x0002 – EDACS</li> <li>• 0x0010 – AMPF</li> <li>• 0x0020 – undefined</li> </ul>
DSP VER	DSP Software Version
FLSH VER	FLASH Software
L3HARRIS (C) 2015	Copyright
PERSNLTY	Personality Name
BLD DATE	Date host (ARM) code was built.
BLD TIME	Time host (ARM) code was built.



## 10.15 BACKLIGHT ADJUST

1. Press  to access the menu.
2. Press  or  to scroll through menu until “BACKLGHT” appears.
3. Press  to select the backlight menu.
4. Press  or  to scroll through available settings off, 1 through 6.
5. Press  to select new backlight setting.

## 10.16 CONTRAST ADJUST

1. Press  to access the menu.
2. Press  or  to scroll through menu until “CONTRAST” appears.
3. Press  to select Contrast menu.
4. Press  or  to adjust contrast setting from 1 - 4.
5. Press  to select new contrast setting.



## 10.17 DECLARE AN EMERGENCY

1. Press and hold the red Emergency/Home button. The length of time to hold the button is programmable; check with the system administrator.
2. **\*TXEMER\*** will flash in the display, and  will be displayed. After 2-3 seconds the transmit icon  will turn off.







3. **\*TXEMER\*** continues to flash until the emergency is cleared. See Section 10.23 for additional emergency operation.
4. Press the PTT and  will reappear.
5. Release PTT when the transmission is complete.

## 10.18 LOCKING/UNLOCKING KEYPAD



1. Press  button.
2. Within 1 second, press the  button on the side of the radio.

## 10.19 HIGH/LOW POWER ADJUSTMENT

Transmit power adjustment is possible if enabled through programming. Within conventional systems, transmit power is adjustable on a per channel basis. Within EDACS trunking systems, transmit power is adjustable on a per system basis.

1. Press .
2. Using the  or  keys, select "TX POWER."
3. Press  again to toggle between High and Low power.
4. "POWER = HIGH" or "POWER = LOW" will appear momentarily on the top line of the display.

## 10.20 ENCRYPTION

The XG-75P portable radio supports AES and DES encryption. When operating on a group or channel programmed for encryption, all transmissions are encrypted, and the radio receives clear and encrypted signals. The  icon is displayed when encryption is enabled. If enabled via programming, the encryption can be enabled or disabled by pressing the  key and selecting the **PRIVATE** menu option. If not enabled, the radio displays **FRCD PVT** when you try to disable encryption.

### 10.20.1 Displaying the Currently Used Cryptographic Key Number

To display the Currently Used Cryptographic Key Number for either the system encryption key (for special call such as individual, phone, all, agency or fleet) or the group/channel key (for group or conventional calls), perform the following procedure:





1. Press the .
2. Use the  or  button to select **DISP KEY**.
3. Use the  or  button to toggle between displaying the system key (Figure 10-12) or the group/channel key (Figure 10-13).



Figure 10-12: System Encryption Key Display

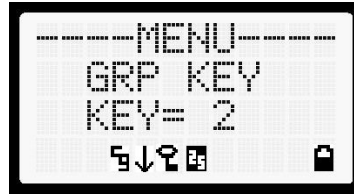





Figure 10-13: Group/Channel Encryption Key Display

### 10.20.2 Key Zero



All cryptographic keys can be zeroed (erased from radio memory) by pressing the  button and while still pressing this button, press and hold the  button. Press both buttons for 2 seconds. A series of beeps will begin at the start of the 2 second period and then switch to a solid tone after the keys have been zeroed. The display will indicate **KEY ZERO**.

If the cryptographic key(s) are zeroed, one or more keys must be transferred from the Keyloader into the radio before private communications may continue.

### 10.20.3 Receiving an Encrypted Call

When receiving, the radio automatically switches between clear or private operation. If the transmission being received is an encrypted transmission, it will be decrypted, the  icon will be displayed, the receiver will unsquelch, and the message will be heard in the speaker. For this to occur, the selected group or channel must be programmed for private operation and the correct cryptographic key must be loaded into the radio.

### 10.20.4 Transmitting an Encrypted Call

1. Select the desired group or channel.
2. Place the radio in Private Mode by pressing  key, then select **PRIVATE** from the menu. On a System radio, the  key can be used to toggle the Private Mode on/off. When Private Mode is enabled, the  icon is displayed.
3. If the last state of the radio was Private Mode, the Private Mode will be enabled on power-up. Also, the Private Mode will be enabled if forced operation has been programmed in the radio.

If a group or channel is not programmed for Private Mode operation, **PVT DIS** will be displayed if an attempt is made to enable private transmit mode. It is not possible to operate on this group/channel in Private Mode.

If the radio does not have the correct encryption key loaded, **NOKY** will be displayed and the call will not be transmitted.

4. Continue with standard transmission procedures. A Private Mode access tone will be heard when the PTT button is pressed.



### 10.20.5 Emergencies on Encrypted Group

The radio can be programmed to allow emergency calls to be transmitted in the clear when the radio does not have the key, or has an invalid key for the encrypted group in emergency.

## 10.21 SCANNING TRUNKED GROUPS

Groups that have been previously added to the scan list on a per system basis may be scanned. Each system's group scan list is retained in memory when the radio is powered off or when the battery pack is removed.

### 10.21.1 Turning Scan On and Off

1. Toggle Scan operation on by pressing **SCN** (Scan model) or **3 SCN** (System model).  icon rotates clockwise to indicate radio is scanning.
2. Toggle Scan operation off by again pressing **SCN** (Scan model) or **3 SCN** (System model).  will disappear.







If the radio scans to a group other than the selected group then receives a call on the selected group, the radio will switch to the selected group. However, if the "scanned-to" group is programmed at a higher priority the radio will remain on the "scanned-to" group.

The radio will continue scanning if a new group is selected when scan is on.

3. Pressing the PTT button when scan is on will cause the radio to transmit on the displayed group or to the currently selected group (depending on programming).

### 10.21.2 Adding Groups to a Scan List

#### Scan Model Radio

1. Scan must be off to add/delete groups to/from the scan list. If the Scan icon  is on, press the **SCN** key to turn Scan off.
2. Select the desired group using the System/Group/Channel control knob and/or the  or  keys. If the selected group is currently on the list, pressing **A/D** will display  on line three.
3. If the scan list status icon is blank, the group can be added to the scan list by pressing the **A/D** key.  will be displayed on line three.
4. Press the **A/D** key a second time to set the group to Priority 2. A  is displayed on line three.
5. Press **A/D** a third time to set the group to Priority 1. A  is displayed on line three. The priority level section sequence only advances the group to the next high priority level and stops at priority level 1. To select a lower priority level, the group must be deleted from the scan list and then added back to the scan list. Each new group added to the scan list starts at the lowest priority. If the Priority 1 and Priority 2 groups are already set and a new group is assigned as Priority 1 or Priority 2, the previously assigned group will change to non-priority scanning. One of the following messages may be momentarily displayed.

**SCAN DIS** The radio is not programmed to scan.

**FIXED P1** A Priority 1 group has been pre-programmed into the radio. A new Priority 1 group cannot be selected.

**FIXD LST** A fixed scan list has been pre-programmed into the radio. It is not possible to change the list without reprogramming the radio.



NOTE

To quickly view multiple group scan status, press **A/D** then rotate the group knob. Each group status will appear on the display.

### System Model Radio

1. With scan operation turned off, select the desired group to add to the selected trunked system group scan list.
2. Press **6 ADD**. The current priority status of the group will be displayed in column 10 of line three for a time-out period. If the group is not part of the scan list, the status will be blank.
3. While the status is displayed, press **6 ADD** to add the group to the scan list. The **III** icon is displayed on line three.
4. Press **6 ADD** a second time to set the group to Priority 2. The **II** icon is displayed on line three.
5. Press **6 ADD** a third time to set the group to Priority 1. The **I** icon is displayed on line three. The priority level selection sequence only advances the group to next higher priority level and stops at priority level 1. To select a lower priority level, the group must be deleted from the scan list and then added back to the scan list. Each new group added to the scan list starts at the lowest priority. If the Priority 1 and Priority 2 groups are already set and a new group is assigned as Priority 1 or Priority 2, the previously assigned group will change to non-priority scanning. One of the following messages may be momentarily displayed.

**SCAN DIS** The radio is not programmed to scan.

**FIXED P1** A Priority 1 group has been pre-programmed into the radio. A new Priority 1 group cannot be selected.

**FIXD LST** A fixed scan list has been pre-programmed into the radio. It is not possible to change the list without reprogramming the radio.



NOTE

To quickly view multiple group scan status, press either **6 ADD MNG** or the **9 DEL RXYZ** key. Then rotate the group knob. Each group status will appear on the display.

### 10.21.3 Deleting Groups from a Scan List

#### Scan Model Radio



1. With scan operation turned off, select the desired group to delete from the selected trunked system group scan list.
2. Press **A/D**. The status of the group is displayed for a time-out period.
3. While the status is displayed, press **A/D** until the group from the scan list is "**blank**." The sequence is "**blank**," **III**, **II**, **I**, "**blank**." Any group that is not in a trunked system group scan list will show a "**blank**" for the time-out period when it is the selected channel.

#### System Model Radio

1. With scan operation turned off, select the desired group to delete from the selected trunked system's group scan list.
2. Press **9 DEL**. The status of the group is displayed for a time-out period.

- While the status is displayed, press  to delete the group from the scan list. **III**, **II**, or **I** turns off. Any group that is not in a trunked system group scan list will show a "**blank**" for the time out period when it is the selected channel.

#### 10.21.4 Nuisance Delete

A group can also be deleted from the scan list, if it is not the currently selected group, by pressing the  key (Scan model) or the  key (System model) during scan operation while the radio is displaying the unwanted group. The group will be deleted from the system's group scan list in the same manner as if done using the steps above. Deletions done in this manner will not remain deleted if the radio is powered off and then powered on.

#### 10.21.5 Mixed Zone Scan

The Mixed Zone Scan (MZS) feature gives the user the capability to scan based on a custom scan list that is assigned at the system level. The Custom Scan (CS) list can contain System and Channel/Group configurations across P25 Trunk, P25 Conventional, and Analog Systems. When a Custom Scan List is defined on a P25T system, the radio can scan P25T, P25C and Analog systems. When defined on a P25C or Analog system, the radio only scans conventional channels. MZS also gives the user the capability to scan beyond the selected system group set.

- **P25T Scan**

When a custom scan list is assigned to a P25T system, the user has the ability to scan P25T, P25C, and Analog groups/channels. All P25T systems must have the same WACN, System ID, and Unit ID to be added to the custom scan list.

- **P25C and Analog Scan**

When a custom scan lists is assigned to a P25C or Analog System, the user has the ability to scan P25C and Analog channels. P25T systems are ignored.

##### 10.21.5.1 Custom Scan List Selection

The Custom Scan List is assigned at the System level. Scanning protocols (Custom Scan, System Scan, and Conventional Priority Scan) are mutually exclusive. Once a custom scan list is assigned to a system, when you enable scan, you are scanning the channel/groups defined in the custom scan list. A Custom Scan List can be assigned to a system through RPM only. The radio supports up to 10 Custom Scan lists, with up to 50 channels/groups in each.

##### 10.21.5.2 View Custom Scan Lists



Scan must be off to view a Custom Scan List.

- From the radio menu, select **CUSTSCAN**.
- Select the desired group/channel from the Custom Scan list. Options available for each channel/group include:
  - View the channel's/group's scan priority.
  - Delete the channel/group from the scan list.

- Nuisance delete the channel/group.
- 3. Press the Option button to back up one display; press the Clear button to return to the home screen.

### 10.21.5.3 Edit Custom Scan Lists



Scan must be off to edit a Custom Scan List.

1. From the radio menu, select **CUSTSCAN**.
2. Select **EDIT LST**.
3. Select the desired system from the list.
4. Select the desired channel group. Scroll through available options:
5. Add the channel/group to the scan list.
6. Change the channel's/group's scan priority.
7. Delete the channel/group from the scan list.
8. Nuisance delete the channel/group.
9. Press the Option button to back up one display; press the Clear button to return to the home screen.

## 10.22 SCANNING TRUNKED SYSTEMS

The radio can be programmed using Radio Personality Manager (RPM) with the following System Scan features. Then these features are automatically enabled when the radio is powered on. A key or menu option is also defined to allow the System Scan features to be toggled during radio operation. The System Scan state will be maintained through system changes but will default to on when the radio is powered on.

### Enable/Disable via Menu Selection

Press **[M]** and then use the **[v]** or **[^]** buttons to scroll through the selections until **SYS SCAN** is displayed. Then press **[M]** to toggle the System Scan state. The **SYSC ON** or **SYSC OFF** display message is displayed for two seconds to show the new state.

### Enable/Disable via Pre-Programmed Keypad Key

Press the key pre-programmed to toggle System Scan and the **SYSC ON** or **SYSC OFF** display message is displayed for two seconds to show the new state.

### **10.22.1 Wide Area System Scanning**

The XG-75P series radio can be pre-programmed through RPM for Wide Area System Scan operation for roaming across mobile systems. EDACS radio systems manage the radios assigned to the system via a control channel (CC). Upon the loss of the currently selected system's control channel, radios can be programmed to automatically scan the control channels of other systems. If a new control channel is found, the radio will switch to the new system and sound an alert tone. The amount of time before the radio enters Control Channel Scan after losing the control channel is configurable in RPM.

### **10.22.2 Priority System Scan**

The radio can also be pre-programmed for Priority System Scan. The priority system is the desired or preferred system. While receiving the control channel of the selected system, the radio will periodically leave the selected system and search for the control channel of the priority system. This is done at a pre-programmed rate defined by the value in the Priority Scan Time control, unless the ProScan™ algorithm is enabled, as explained in the following sections. This priority scan timer is reset each time the PTT button is pressed or when the call is received. If the priority system control channel is found, or meets the predefined criteria (ProScan), the radio will automatically switch to the priority system.

#### **10.22.2.1 Enabling the Wide Area System Scan Function**

If the radio cannot find the control channel of the selected system and begins to wide area system scan, the radio will only scan for the priority system control channel if the priority system is in the wide area scan list.

#### **10.22.2.2 When ProScan is Enabled**

The radio monitors the priority system and will switch to the priority system if the pre-programmed criteria ProScan options are met. If ProScan is enabled, the rate at which the radio will scan for the priority system is defined by the System Sample Time control, set in RPM (refer to RPM On-Line Help). See Section 10.22.3 for more information on ProScan.

### **10.22.3 ProScan**

The radio may be programmed for ProScan system scan operation for multi-site applications. ProScan is a multi-site, system-scanning algorithm. ProScan provides the radio with the ability to select a new system for the radio to communicate on, when the selected system drops below a predefined level. This algorithm enables each radio to analyze the signal quality of its current control channel and compare it with the signal quality of the control channel for each site in its adjacent scan list. The signal quality metric used for the ProScan algorithm is based on a combination of both Received Signal Strength Indicator (RSSI) and Control Channel Verification (CCV) measurements. When the selected system degrades to a pre-programmed level, the radio will begin to look for a better control channel. Once a control channel that exceeds the pre-programmed parameters is found, the radio will change to the new system and emit a tone (if enabled through programming). If the control channel is completely lost, the radio will enter Wide Area System scanning and search the programmed adjacent systems until a suitable control channel is found.

## 10.23 EMERGENCY OPERATION

The radio's ability to declare an emergency, clear an emergency, remain locked on an emergency system and group, and the emergency audio and display freeze can each be enabled or disabled through programming. When an emergency is declared, scanning will stop and restarts only after the emergency has been cleared.

### 10.23.1 Receiving an Emergency Call

When receiving an Emergency Call on the selected group and system, an alert beep is heard and **Y** is displayed. The message **\*RXEMER\*** flashes in the display on line two until the emergency condition is cleared.

### 10.23.2 Declaring an Emergency Call

Perform the following steps to send an emergency call to a selected system and group (or on an optionally pre-programmed group).

1. Press and hold the red EMERGENCY button that is on top of the radio in front of the antenna for approximately one second (this time is programmable and therefore could be longer or shorter; check with the system administrator). The radio will transmit an emergency call request with the radio ID until an emergency channel assignment is received.
2. When the working channel assignment is received, the radio sounds a single beep indicating the radio has auto keyed (see Table 10-4) and is ready for voice transmission. **\*TXEMER\*** flashes on line two in the display until the emergency is cleared.
3. Press PTT and speak into the microphone in a normal voice. **↑** and **Y** momentarily turn on.
4. Release PTT when the transmission is complete.

To clear the emergency, first press and hold the **⊙** button. While continuing to hold the **⊙** button, press the EMERGENCY button. The radio must be programmed to clear emergencies.



## 10.24 MIXED SYSTEM ZONES

A Zone is a grouping of analog conventional channels, P25 conventional channels, and/or talkgroups. Mixed System Zones are defined in RPM and can be comprised of any combination of channels/groups from multiple systems. If a Mixed System Zone is not configured in RPM, it will not appear on the radio. Up to 50 Mixed System Zones can be defined.

To select a Mixed System Zone:

1. Press **M**.
2. Press **▼** or **▲** to select **ZONE** and press **M**.
3. Press **▼** or **▲** to select the desired Mixed System Zone and press **M**.

Alternately, the System/Group/Channel knob or a button on the radio can be programmed to scroll through available Mixed System Zones.

When scan is enabled on a system in a Mixed System Zone, the radio continues to display the zone name or system name per the current radio mode (system/zone). When toggling scan ON/OFF, there is no change one line 1 of the radio display. If it is showing system name, it continues to show system name; if it is showing zone name, it continues to show the zone name during scanning.

## 10.25 CALLER ID

This feature allows you to view the caller ID or alias for up to the last 10 received calls. Received calls include Group, Announcement, Phone, Patch, SimulSelect, Agency, Fleet, and MDC.

1. Press **M** and press **▼** or **▲** to select **CALL ID**. Press **M**. Alternately, a button can be programmed to access the **CALL ID** list.
2. Press **▼** or **▲** to scroll through available entries. The most recent call is displayed at the top of the list. "NO ENTRY" is displayed if there are no entries.
3. Caller ID or "NO ENTRY" is displayed for 10 seconds. Press the Clear button to exit the Caller ID list.

The most recent call is displayed at the top of the list. The Caller ID list is cleared when power is cycled on the radio.

## 10.26 STEALTH MODE

Press the button programmed for Stealth Mode operation to toggle Stealth Mode on or off. During Stealth Mode, all buttons are disabled except PTT, the button programmed for Stealth operation, Emergency, and Nuisance delete. The radio will receive and transmit when Stealth Mode is enabled.

The radio can be configured to disable any or all the following during Stealth Mode:

- LCD display
- LED
- Backlight
- Side/alert tones

Stealth Mode can be configured to persist through a power cycle.

## 10.27 INDIVIDUAL CALLS

### 10.27.1 Receiving and Responding to an Individual Call

When the radio receives an individual call (a call directed only to the user's radio), it un-mutes on the assigned working channel and displays **Y**. The first line on the display shows the logical ID number of the unit sending the message, or the associated name if the ID number is found in the individual call list. The radio can be programmed to ring when an individual call is received. If enabled, the ring begins five seconds after the caller un-keys and will continue until the PTT button, the **Ⓢ** button, or the individual call mode is entered.



The volume of the ring is adjustable through the volume control levels.

If a response is made by pressing the PTT to the call prior to the programmed call-back time-out, the call will automatically be directed to the originating unit. If a response is not made before the call-back time-out, the radio will return to normal receive display, and **\*WHC\*** will appear on the first line of the LCD.

To respond after the call-back time-out, press the **#IND** key. The radio's display will show the callers ID on the first line and **WHCI=1** on the second line. Pressing the PTT button at this point will initiate an individual call back to the original caller.

The radio stores the IDs of the last 10 callers in the Calls Received List as shown. Individual calls are stored in the top half of the list (1-10) and Group calls are stored in the bottom half of the list (1-10). The most recent call is stored in position 1, the second most recent call is stored in position 2, etc.

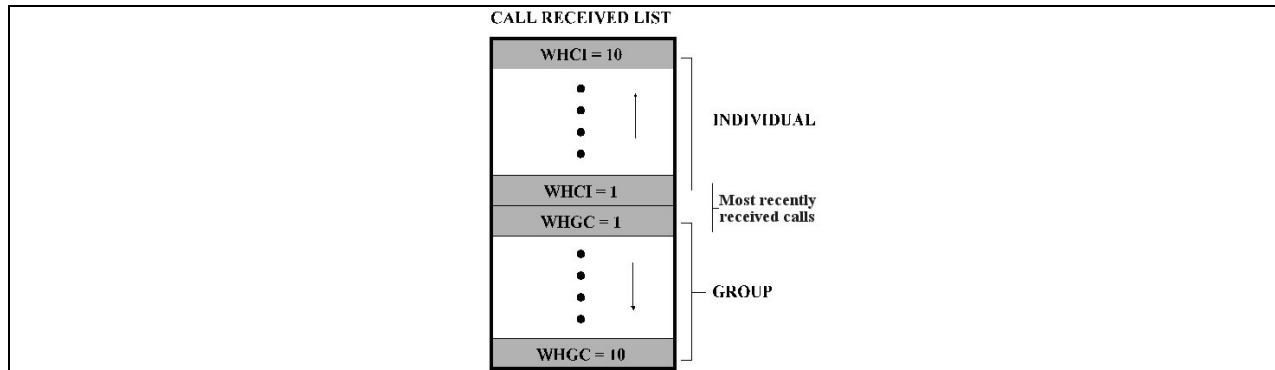

**Figure 10-14: Calls Received Lists**

To access the Calls Received List, press the **#IND** key twice. Use the **▼** or **▲** buttons to scroll through the list. Pressing the **M** key will display the time elapsed since the call was received. After pressing **#IND**, the display will appear similar to Figure 10-15.

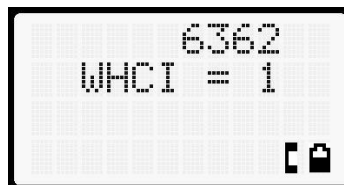

**Figure 10-15: WHC Individual Call Display**

Pressing the PTT will initiate an individual call to the displayed logical ID. Powering the radio off and on will clear this list.

## 10.27.2 Sending an Individual Call

### 10.27.2.1 Pre-Stored Individual Calls

The following procedures describe how to initiate and complete a Pre-Stored Individual Call.

#### System Model Radio

1. To select a pre-stored individual phone number, enter the individual call mode using the **#IND** key. **IND** is displayed. Then scroll through the list of stored numbers using the **▼** or **▲** keys.
2. Press the PTT button; when the radio is clear to transmit, **PTT** turns on, **IND** turns off, and the channel access tone sounds. Line one shows the called individual's name if found in the list of stored individuals or **LID** followed by the logical ID number of the unit being called. The message **\*INDV\*** displays on line two.

#### Scan Model Radio

1. To select a pre-stored individual number, enter the menu mode by pressing the **M** key. Scroll through the mode list using the **▼** or **▲** buttons.
2. Press **M**. **IND** is displayed. Scroll through the list of stored phone numbers using the **▼** or **▲** buttons until the desired number is displayed. Press **M**.
3. Press the PTT button; when the radio is clear to transmit **PTT** turns on, **IND** turns off, and the channel access tone sounds. Line one shows the called individual's name or LID. The message **\*INDV\*** displays on line two.

### 10.27.2.2 Direct Dial Individual Calls (System Model Only)

1. The following procedure describes how to initiate and complete a Direct Dial Individual Call.
2. The individual call ID is not stored in the pre-stored list of call IDs but the individual unit ID is known, it can be entered directly from the keypad.
3. Press and hold the PTT button to transmit. **PTT** will turn on, **IND** will turn off, and the channel access tone will sound. Line one shows the called individual's ID followed by the logical ID number of the unit being called. The message **\*INDV\*** displays on line two. Proceed talking into the microphone.

## 10.27.3 Call Storage Lists

There are two lists available for call storage in the XG-75P series radios, the calls received list (1 - 10) and the personality list (1 - 99 as defined by the user). When the individual call mode is entered by pressing **#IND**, the calls received list is available. The user can toggle to the personality list by selecting any index other than 0 or toggle between the two lists by pressing the **#IND** key. If wrap is enabled, the calls received list wraps on itself and not into the other list.

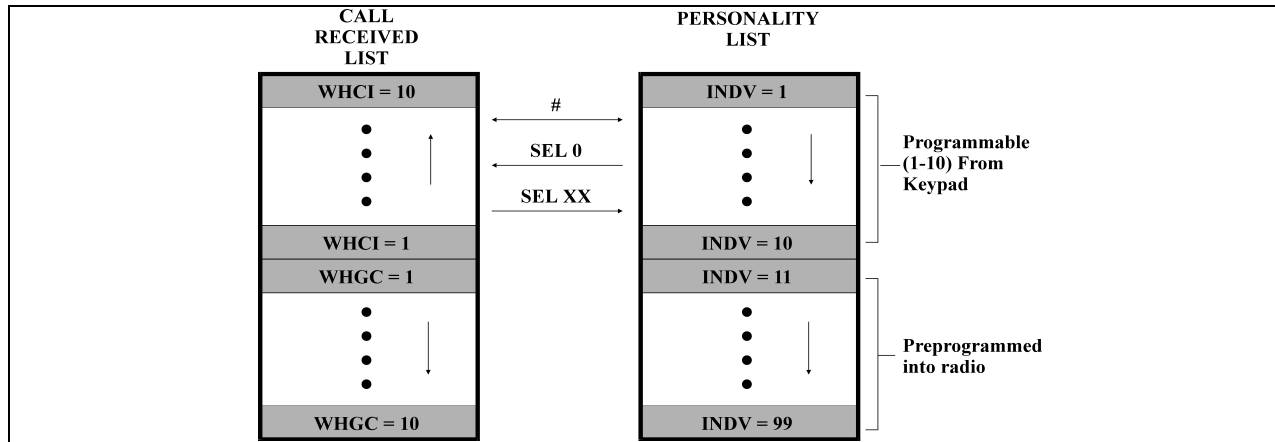

**Figure 10-16: Calls Received and Personality Lists**

The saved call list shows all ten storage locations. If no calls have been received, the saved call list will be empty and the pre-stored list will be available upon entering the individual call mode.

When in the saved call list, pressing the **M** key toggles the time stamp on and off. The time stamp indicates how long ago the call was received. When in the pre-stored list, pressing the **M** key toggles the Logical Identification (LID) on and off.

## 10.28 TELEPHONE INTERCONNECT CALLS

### 10.28.1 Receiving a Telephone Interconnect Call

When the radio receives a telephone interconnect call (a call directed only to the user's radio), it un-mutes on the assigned working channel and displays **T**. The first line displays **\*PHONE\***. The second line displays **\*INDV\***. Proceed with the call. Press the PTT to talk, release the PTT to listen.

### 10.28.2 Sending a Telephone Interconnect Call

#### 10.28.2.1 Pre-Stored Number

Use the following procedures to initiate and complete a Telephone Interconnect call.

1. **System Model:** To select a previously stored phone number, press the **\*PIN** key. Use the **▼** or **▲** buttons to scroll through the list of stored numbers.

**Scan Model:** To select a previously stored phone number, press the **M** key. Use the **▼** or **▲** buttons to select the menu option **PHN CALL**. Press the **M** key again then use the **▼** or **▲** buttons to scroll through the list of pre-stored numbers.

2. Press and release the PTT button. When the radio is clear to transmit, **T** turns on, **L** turns off, and the channel access tone sounds. Line one shows the accompanying name selected from the list of stored numbers. The message **\*PHONE\*** appears on line two of the display. The radio then automatically transmits the programmed number stored in the special call queue.
3. A telephone ring will be heard from the speaker. When someone answers the phone, press the PTT button and speak into the microphone. Release the PTT button to listen to the callee. Unsuccessful interconnect signaling returns the radio to the normal receive mode and the

number remains displayed until the special call is cleared or the time-out expires or another group or system is selected. Terminate a call by pressing the ☎ button.



In half-duplex mode, only one person may talk at a time. The radio PTT button needs to be pressed in order to communicate to the individual called and released for the individual called to be heard.

### 10.28.2.2 Direct Dialing of Phone Calls (System Model Only)

1. If the phone number is not stored in the pre-stored list of phone numbers, but the phone number is known, it can be entered directly from the keypad. Start by pressing the [\*PHN] key, then enter the required number from the keypad. Press and release the PTT button.



The last number directly entered can be recalled by first pressing [\*PHN] then pressing the PTT button.

2. A telephone ring can be heard from the speaker. When someone answers the phone, press and hold the PTT button and speak into the microphone. Release the PTT button to listen to the individual called. Unsuccessful interconnect signaling returns the radio to the normal receive mode and the number remains displayed until the special call is cleared or the time-out expires or another group or system is selected.
3. To terminate the call, momentarily press the ☎ button.

### 10.28.3 Dual-Tone Multi-Frequency: Overdial

Once the radio has established a connection to the public telephone system, it may be necessary to “over-dial” more digits to access banking services, answering machines, credit card calls, or other types of systems that require Dual-Tone Multi-Frequency (DTMF) access digits.

Overdial operation can also be used to initiate a telephone interconnect call via DTMF signaling if a dial tone has already been accessed on the system. This method makes a telephone interconnect call while operating in the conventional mode but will also function in trunked mode if a dial tone is directly accessible.

Telephone numbers and other number sequences for overdialing can be stored in the phone list when programming the radio. These numbers are accessed by pressing the [M] key, then following the selection mode rules. Perform the following procedures to access and dial these stored numbers.

#### Scan Model Radio

1. Follow the procedure in Section 10.28.2 to establish a connection to the telephone system or consult the system administrator for the procedure to access a dial tone on the trunked or conventional system.
2. Enter selection mode first to enable entry of overdial numbers by pressing the [M] button.
3. Follow the selection mode rules to call up a stored number from the phone list: Use the [▼] or [▲] buttons to scroll through the list of stored numbers. [ ] is displayed. Press the PTT to send the overdial sequence once. If the number needs to be transmitted again it must be selected or entered again (this prevents unwanted numbers from being sent the next time the PTT button is pressed during the call).

Overdial select/entry mode remains active until the call is dropped, cleared, or **M** is pressed. The overdial select/entry mode can be re-entered if the call is still active by pressing **M**.

### System Model Radio

1. Follow the procedure in Section 10.28.2 to establish a connection to the telephone system or consult the system administrator for the procedure to access a dial tone on the trunked or conventional system.
2. Overdial numbers are transmitted using one of the following methods:

METHOD 1: 1. Enter the overdial selection mode by pressing the **\*PIN** button.

2. Use the **▼** or **▲** buttons to scroll through the list of stored numbers. **█** is displayed. Press the PTT to send the overdial sequence once. If the number needs to be transmitted again it must be selected or entered again (this prevents unwanted numbers from being sent the next time the PTT button is pressed during the call).

METHOD 2: **(System model radios only)**

1. Enter the overdial selection mode by pressing the **\*PIN** button.
2. Press and hold the PTT button while entering the overdial number sequence from the keypad. This method sends DTMF tones during individual, telephone interconnect, trunked group, or conventional channel calls. Press the PTT to send the overdial sequence once. If the number needs to be transmitted again it must be selected or entered again (this prevents unwanted numbers from being sent the next time the PTT button is pressed during the call). ***Anytime the PTT button is pressed and held, the keypad is enabled for DTMF entry.***

This overdial select/entry mode remains active until dropped, cleared, or **M** is pressed. The overdial select/entry mode can be re-entered if the call is still active by pressing the **\*PIN** button.

## 10.29 PRE-STORING INDIVIDUAL AND TELEPHONE INTERCONNECT CALLS FROM THE KEYPAD

Individual Call ID numbers, telephone numbers, and other number sequences for over dialing are stored in the special calls lists when programming the radio. The first ten entry locations of these lists can be changed by the radio operator. The keypad is used when adding, changing, and storing numbers in these entry locations.

Use the following procedure to store a number in one of the first ten entries of a special call list:

1. Press the **#IND** or **\*PIN** button to enter the individual call list or the phone call list. **█** is displayed.
2. Scroll through the list using the **▼** or **▲** keys until one of the first ten entries is reached. **NO ENTRY** is displayed if the location is empty.
3. Enter the desired number. If necessary, a pause can be entered by pressing and holding 0-9, **#IND**, or **\*PIN** until an underscore appears in the display (telephone interconnect only). The individual call list entries will accept up to 5 digits. The phone call list entries accept a combination of up to 31 digits and pauses.

4. Press and hold the **M** key until the display changes indicating that the number has been stored.

Repeat steps 1-4 to store additional numbers, to change numbers already stored, or to change the storage location of a number.

## 10.30 STATUS/MESSAGE OPERATION

The **Status** and **Message** operations allow for the transmission of a **pre-programmed status** or a **pre-programmed message** to an EDACS or P25 site. Each Status and Message is assigned an ID then cross-referenced with the representative status condition (“Off Duty,” for example) or a message (“Call home”). In addition, Status conditions can also be associated with a programmable Menu entry (required for second method of transmitting a Status condition).

### 10.30.1 Status Operation

#### System Model Radio

One of two methods can be used to transmit a status condition.

METHOD 1: 1. Press the **M** key, then use the **▼** or **▲** buttons to scroll to the pre-programmed status condition. STATUS and 0 through 9 pre-programmed status selections are available from the menu.

2. If STATUS is selected, you need to enter the number of the status condition you intend to transmit. If no status has been programmed for the selected number key, the radio will display **NO ENTRY**. A valid selection will display the status for a pre-programmed time.

METHOD 2: 1. Press the **7 PGM** key.

2. Press the corresponding pre-programmed 0 through 9 status condition key. If no status has been programmed for the selected number key, the radio will display **NO ENTRY**. A valid selection will permit the status condition to appear in the top line of the display and the status ID to appear in the second line of the display for a pre-programmed time.

After the time-out expires or the **M** key has been pressed (the **M** key will override the time-out period), the status is selected and will be transmitted to the site or stored in the radio memory where it can be polled by the site at a future time.

To view the currently selected status after it has been transmitted, press the **M** key and then the **▲** key to ramp to STATUS, press the **M** key again and then the **⊙** button prior to the time-out period. If the status was not sent successfully to the site, the text associated with the status will flash in the display.

The status selection can be changed by pressing a different status key 0 through 9, or the status operation can be cancelled by pressing **⊙**. Both operations must be carried out prior to the time-out period.

### 10.30.2 Message Operation

The following method can be used to transmit a Message using the Message Operation.

1. Press the **8 MSG** key.
2. Press the corresponding pre-programmed 0 through 9 pre-programmed “message” key. If no message has been programmed for the selected number key, the radio will display **NO ENTRY**. A valid selection

will permit the message to appear in the top line of the display and the message ID to appear in the second line of the display for a pre-programmed time.

The message selection can be changed by pressing a different message key 0 through 9, or the message operation can be cancelled by pressing . Both operations must be carried out prior to the pre-programmed time-out period.

### 10.31 DYNAMIC REGROUP OPERATION (EDACS)

Dynamic Regroup Operation permits multiple Talk Groups (up to eight) to be added to a radio via the system manager. The radio must be pre-programmed to respond to regrouping. Dynamic regrouping will not be activated in a radio until the system manager sends an activation message. Each radio that receives and acknowledges the regrouping instructions is successfully regrouped.

Pressing and holding the  button for 2.5 seconds toggles the user into and out of the dynamic regroup groupset. A double beep will sound for entry or exit. The display will indicate **REGRP\_0x** where "x" is a digit of 1 to 8 indicating the group (when dynamic regroup has been enabled by the user). If the radio is in dynamic regroup and the user selects a group that has not been regrouped, the display will show **NO ENTRY**. The radio will be prevented from transmitting and receiving calls in this condition except for scanned groups.

After the time-out expires or the  key has been pressed, the status is selected and is transmitted to the site or stored in radio memory where it can be polled by the site at a future time.

If the pre-programmed groupset on the currently selected system contains an EMER/HOME group and the radio is in dynamic regroup, the radio will declare the emergency on the currently selected dynamic group.

### 10.32 MACRO KEY OPERATION

Macro key operation permits the user to accomplish a series of keystrokes with a single "macro" keystroke. Each macro key can execute up to twenty (20) keystrokes, to any push button input (i.e., keypad keys, option buttons, etc.). Each macro key can be pre-programmed to activate when pressed or when released. A macro key can also be pre-programmed to change the key stroke sequence the next time the macro key is activated.

For detailed operation and assignment of macro keys, contact your communications supervisor or administrator.

### 10.33 DATA COMMUNICATIONS

The XG-75P series portable radios permit both voice and data calls to be transmitted and received. The radio can handle only one type of call at a time; however, either data or voice is selected transparently by the operator through normal usage of the radio.

The radios can be connected to a Mobile Data Terminal (MDT) or to a host computer. Any RS-232 compatible device that supports the Radio Data Interface (RDI) protocol (Version 1.91 or greater) may be connected to the radio. Support for MDTs or host computers is a programmable option per radio. Additionally, radios may also be programmed for data only operation (no voice calls transmitted or received).



### 10.33.1 Displays

The following will be displayed during data operation:

- DATA T/R**     Appears on top line of display when the radio is transmitting/receiving a data call.
- DATA OFF**     Appears on top line of display when the radio is in the data disabled state.
- DATA ON**     Appears for two seconds on top line of display when the radio is toggled to the data enabled state.

### 10.33.2 Data Off Operation

The radio can be placed in the data disabled state by any of the following methods. When the data state is disabled, **DATA OFF** appears on the top line of the display.

- Declaring an emergency (not to be used unless an actual emergency condition exists). Alert tone will sound.
- Pressing button  $\bigcirc$  (if pre-programmed as “no data” key). Alert tone will sound.
- Pressing the pre-programmed “no data” key. Refer to previous bullet.

### 10.33.3 Data On Operation

The data state is enabled by one of the following (depending on how it was disabled). **DATA ON** will appear on the top line in the display for two seconds; then the display will return to normal.

- Pressing the pre-programmed “no data” (ND) key toggles data state on or off.
- Clearing an emergency. ***This is valid only if the emergency caused “DATA OFF” operation.***

### 10.33.4 Exiting Data Calls



Under normal conditions, the radio enters the scan lockout mode and returns to the control channel after completion of a data call (transmit or receive). If, during a data call, one of the following operations occurs, the data call is immediately terminated and the radio performs the desired function:

- If the PTT is activated.
- If an Emergency is declared by pressing the pre-programmed emergency button.
- If a group or system is changed.

### 10.33.5 Scan Lockout Mode

Following the transmission or reception of a data call, if scan is enabled, scanning will stop temporarily. There are two independent pre-programmed times associated with this mode; one after a received data call and one after a transmitted data call. During this time, the scan indicator will flash to indicate that scan is enabled but temporarily suspended. This condition typically returns to normal scan operation when the pre-programmed time expires; however, the following operations and conditions will terminate the scan lockout mode before the timeout has expired.

- Pressing the  $\odot$  button.
- Pressing the PTT.
- Changing a group or system.

- Entering Telephone Interconnect mode.
- Entering Individual call mode.
- Receiving a new emergency assignment.
- Declaring or clear an emergency.
- Receiving an individual or phone call.
- Receiving an Agency, Fleet, or System All Call.
- Pressing  (Scan model) or  (System model) to toggle Scan on or off.

### **10.33.6 Data Lockout Mode**

During the voice call scan hang time (pre-programmed) the radio does not receive data calls.

## **10.34 SELECTIVE SIGNALING (CONVENTIONAL)**

Selective signaling controls the muting and unmuting of the receive audio. This allows a user or dispatcher to selectively call an individual radio or group of radios. The XG-75P portable radios support selective signaling in Type 99 decode format.

### **10.34.1 Type 99 Operation**

Type 99 is a conventional in-band, two-tone sequential signaling method. This conventional signaling protocol controls the muting and unmuting of a radio. Type 99 encoded base stations, mobiles, or portables can selectively call individual units or groups of units in a conventional system. Type 99 is used in paging operations providing a dispatcher with the ability to selectively call a radio or a group of radios. If Type 99 is enabled in the radio personality, the radio can decode Individual, Group, and Supergroup Type 99 calls.

In a selective signaling environment, the XG-75P portable radios operate in one of two states, Monitor mode or Selective Call mode.

- In Monitor mode, Type 99 "OFF," the decoder is disabled and all calls are heard by the user.
- In Selective Call mode, Type 99 "ON," the decoder is enabled and only calls intended for the user are heard.

### **10.34.2 Type 99 with or without Channel Guard**

Selective signaling operates with or without Channel Guard. If Channel Guard is enabled, the radio can be programmed with an "And" or an "Or" option, determined by programming with T99 Mute Control.



- If the "And" option is programmed, T99 calls require the correct selective signaling (T99 tone sequence) **AND** the correct Channel Guard tones are heard by the user.
- If the "Or" option is programmed, calls with the correct Channel Guard tones **OR** calls with the correct T99 tone sequence and Channel Guard tones are heard by the user.

A radio operating in Selective Call mode that receives a selective call switches to the Monitor mode (after decoding the T99 call) and the **TX/RX LED** flashes green. The **TX/RX LED** indicates whether the channel has a carrier signal.

### 10.34.3 Resetting Type 99 after a Call

After decoding a Type 99 call, the radio operates in Monitor mode and all traffic on the channel is audible. If the channel has Channel Guard, only the traffic with the radio's Channel Guard tone will be heard.

To reset Type 99 operation, use one of the following methods:

- Press the  button.
- Press the  button, if enabled through programming to toggle Type 99 on/off.
- Allow the "Auto-Reset" timer, if enabled through programming, to reset the Type 99 decoder.

### 10.34.4 Type 99 Disable after PTT

The radio may be programmed with the Type 99 Disable after PTT feature, which automatically disables the Type 99 decoder after a transmission.

Use one of the methods outlined in the Section 10.34.3 to reset Type 99 operation.

## 10.35 AUDIO PLAYBACK

Every call received by the radio is recorded in internal memory, overwriting the last recorded call. When the PLAYBACK key is pressed, the last recording is replayed and any future recordings are stopped. Pressing PLAYBACK again repeats the same recorded call. Pressing and holding the PLAYBACK key until the tone sounds erases the recording and starts the recording of incoming calls again. If a call is received while the recorded call is playing, the recorded call continues to play, rather than the received audio. However, if a call is received and the recorded call is played back in close succession received audio could mute call playback. This feature requires RPM R8A and later, and ECP R15A and later.













NOTE

The PLAYBACK function must be programmed to a button on the radio via RPM.

## 10.36 RADIO TEXTLINK OPERATION

Radio TextLink provides a simple means of exchanging pre-defined, or "canned," text messages. This section describes how to send messages if the Radio TextLink feature is enabled.

### 10.36.1 Send TextLink Messages

1. Press  to access the menu.
2. Press  or  to scroll through menu until **SND MAIL** is displayed. Press  to select.
3. Press  or  to scroll through the pre-defined messages that scroll across the top of the display. Press  to select to select the desired message.
4. Press  or  to scroll through the list of available destination IDs and select the desired ID with .

### 10.36.2 View Received TextLink Messages

Received Messages are listed in the order in which they are received (newest at the top). All messages include the user LID along with the date and time stored/displayed. The mailbox can

hold 16 messages at a time. If a new Message arrives after the limit is reached, the new message overwrites the oldest message.

1. Press **M** to access the menu.
2. Press **▼** or **▲** to scroll through menu until **RD MAIL** is displayed. Press **M** to select.
3. Scroll through the list of received messages using the **▼** or **▲** key.
4. Selecting a received message with the **M** key will bring up a reply to sender option.

### **10.36.3 Delete TextLink Messages**

Select **DEL MAIL** with the **M** key to delete ALL messages in the inbox.

### **10.36.4 View the Current Time**

Select **TIME** with the **M** key to retrieve the current date and time.

## **10.37 VIEW GPS INFORMATION**

If GPS is enabled in RPM and the GPS Speaker microphone or GPS dongle is connected to the XG-75P, view your position and satellite information via the GPS Menu. GPS requires an unobstructed view of the sky and the signal is greatly diminished inside buildings, tunnels, heavily forested areas, etc. GPS may not work at all under some conditions, especially in metal enclosures or buildings. **Ψ** flashes on the radio display when the GPS signal is being acquired; stops flashing after signal is acquired.

1. Press **M** to access the menu.
2. Press **▼** or **▲** to scroll through menu until **GPS** is displayed and press **M** to select.
3. Press **▼** or **▲** to scroll through available information screens.

## **10.38 USING THE GPS SPEAKER MIC**

1. Ensure that the GPS Feature Encryption bit is enabled.
2. In RPM:
  - a. Check **Data Options → GPS Enabled**.
  - b. Add "GPS" into the radio menu (from RPM, select **Options → Programmable Menus**, and select GPS from the drop-down).
3. Go outside of a building. Turn the radio on. There is a flashing trident icon in the upper right hand corner of the display. This indicates that the GPS speaker/mic has not yet acquired synchronization with the satellites.
4. When the trident goes solid, the GPS speaker mic has acquired the satellites.
5. Press the **M** button.
6. Scroll down to GPS. The display changes to GPS ON. If it is OFF, then toggle it ON.
7. Scroll down. SPD is for speed and DIR is for direction.
8. Scroll down again.
  - LON is for longitude in degrees, minutes, seconds.
  - LAT is for latitude in degrees, minutes, seconds.

9. Scroll down again. UTC is for Coordinated Universal Time.

## **10.39 CONTROL AND STATUS SERVICES**

The XG-75P supports Control and Status services. These services allow the computer application to monitor and control a radio. The Control and Status Services can be used from a locally-connected Mobile Data Terminal (MDT) or a network MDT. In some cases, the radio can support both MDTs simultaneously. However, priority is given to the local MDT.

The Radio Status Service allows an MDT or Fixed End System (FES) to receive real-time status updates from a radio. An MDT sends Host Attach/Detach messages to the radio as UDP datagrams destined for the UDP Service Address and Service UDP Port of the radio. All responses and asynchronous reports are returned to the address and port of the requesting host. Refer to the *ECP Control and Status Services Feature Manual*, 14221-7200-6040, for more information on this feature.

## 11. PREVENTIVE MAINTENANCE

### 11.1 IMMERSIBLE PREVENTIVE MAINTENANCE

XG-75P radios labeled “immersible” (see Figure 11-1) require periodic testing using specialized equipment to verify the radio’s watertight integrity.

To recertify the watertight integrity of the XG-75P portable radio, the radio must be inspected by a service center authorized and certified by L3Harris to perform the necessary tests to verify the watertight integrity.

The L3Harris Service Network includes company-owned service facilities as well as the capabilities of service partners located throughout the world. We have over 250 Authorized Service Centers (ASC) qualified to perform warranty repairs, installation and maintenance services. For a list of ASCs, contact our Customer Care Center.

#### Preventive Maintenance for Immersion-Rated Radios



CAUTION

XG-75P radios with Immersion Option must be serviced by a service center authorized and certified by L3Harris to perform the necessary tests to verify watertight integrity. As part of a thorough preventive maintenance plan, L3Harris recommends Immersion-Rated XG-75P radios are, at a minimum, tested and re-certified on an annual basis. L3Harris further recommends that the radios be tested on or close to the anniversary of the ship date printed on the Model Number label on the back of the radio (see Figure 11-1).

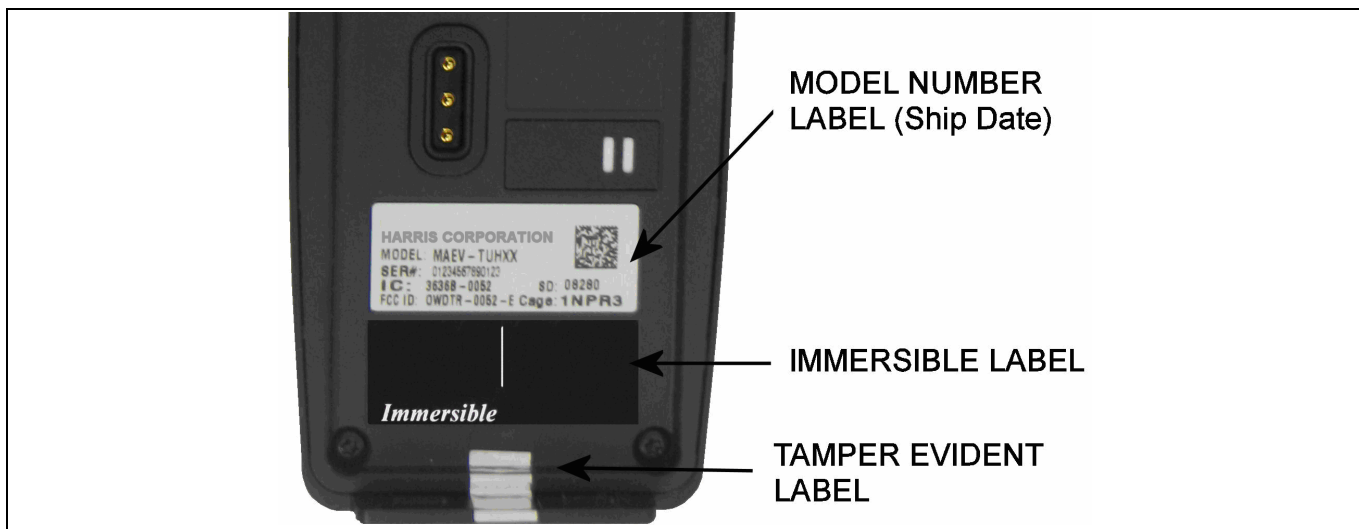



Figure 11-1: Labels

## 11.2 BASIC TROUBLESHOOTING

Use Table 11-1 as a troubleshooting guide if the radio is not functioning properly. If additional assistance is required, contact a qualified service technician or call L3Harris at 1-800-528-7711.

**Table 11-1: Troubleshooting**

SYMPTOM	POSSIBLE CAUSE	POSSIBLE SOLUTION
Radio will not turn on.	Low battery charge.	Change the battery pack to a fully charged pack.
No Audio.	Speaker volume is muted.	Increase the volume level.
Poor Audio.	User is in a poor coverage area or not on the network.	Move to a better coverage area.
Radio powers off for no apparent reason.	Radio may be experiencing very low voltage.	Have the battery checked by an authorized technician.
Radio will not transmit.	Radio may be out of coverage area or may be overheated.	Return to coverage area if possible. If overheated, let radio cool before retrying transmission. Report this failure to an authorized technician.
 CAUTION	<p><b>Though none of the above symptoms or solutions require disassembling the radio, this is a reminder that L3Harris recommends the radio should only be disassembled by L3Harris-authorized and certified service personnel. More importantly, if the radio is covered by Immersion-Rated Option MAEV-PKGMR, then the radio must be serviced by L3Harris authorized and certified service personnel. This is a requirement to maintain the watertight integrity warranted under Immersion Option MAEV-PKGMR.</b></p>	

## 12. CUSTOMER SERVICE

### 12.1 CUSTOMER CARE

If any part of the system equipment is damaged on arrival, contact the shipper to conduct an inspection and prepare a damage report. Save the shipping container and all packing materials until the inspection and the damage report are completed. In addition, contact the Customer Care center to make arrangements for replacement equipment. Do not return any part of the shipment until you receive detailed instructions from an L3Harris representative.

Contact the Customer Care center at <https://www.harris.com/solution/pspc-customer-service> or:

**North America:**

Phone Number: 1-800-368-3277

Fax Number: 1-321-409-4393

E-mail: [PSPC\\_CustomerFocus@l3harris.com](mailto:PSPC_CustomerFocus@l3harris.com)

**International:**

Phone Number: 1-434-455-6403

Fax Number: 1-321-409-4394

E-mail: [PSPC\\_InternationalCustomerFocus@l3harris.com](mailto:PSPC_InternationalCustomerFocus@l3harris.com)

### 12.2 TECHNICAL ASSISTANCE

The Technical Assistance Center's (TAC) resources are available to help with overall system operation, maintenance, upgrades and product support. TAC is the point of contact when answers are needed to technical questions.

Product specialists, with detailed knowledge of product operation, maintenance and repair provide technical support via a toll-free (in North America) telephone number. Support is also available through mail, fax and e-mail.

For more information about technical assistance services, contact your sales representative, or call the Technical Assistance Center at:

North America: 1-800-528-7711

International: 1-434-385-2400

Fax: 1-434-455-6712

E-mail: [PSPC\\_tac@l3harris.com](mailto:PSPC_tac@l3harris.com)



## 13. WARRANTY

Please register this product within 10 days of purchase. Registration validates the warranty coverage, and enables L3Harris to contact you in case of any safety notifications issued for this product.

Registration can be made on-line at the Customer Care center webpage:

<https://www.harris.com/solution/pspc-customer-service>

While on the webpage, please review the applicable battery and/or product warranty literature.

## APPENDIX A CONFIGURING ENCRYPTION

### A.1 ENCRPTION KEYS

Refer to the following documentation for advanced programming and setup instructions:

- L3Harris OTAR Overview Manual - MM-008069-001
- Network Key Manager Installation and Configuration Manual - MM-008070-001
- L3Harris UAS Key Management Application Manual - MM-008068-001
- L3Harris Key Manager Key Admin Overview and Operation Manual - MM1000019423
- L3Harris Key Manager Key Loader Overview and Operation Manual - MM1000019424
- Motorola® Key Variable Loader (KVL) Device User's Guide

#### A.1.1 Create Keys Using Key Admin

Key Admin is part of the Key Manager and is used by the Crypto Officer (CO). The CO creates a Master Set of keys from which a Distribution Set is produced. Using the Key Admin software, the CO can save keys into Distribution key files for technicians to use in radios.

1. Select **Start → Programs → Harris Key Manager → Harris Key Admin**.
2. Select **New Master Set, Open, or Import from Security Device**. Refer to the Key Admin online help for more information on creating keys.
3. When finished, create a Distribution Key File. A Distribution Key File is used with the Key Loader to load key sets into the radio and cannot be edited. Refer to the Key Admin online help for more information on creating the Distribution Key File.

#### A.1.2 Load Encryption Keys

##### A.1.2.1 **Load UKEKS with Key Loader and RPM (for OTAR-Enabled Systems)**

UKEKs are loaded into OTAR radios using the Key Loader application. Key Loader is a part of Key Manager.

To load encryption keys:

1. Obtain the UKEK file and Storage Location Number (SLN) Binding Report information from the Crypto Officer (CO).



NOTE

Both AES and DES UKEKs can be contained within the same UKEK file.

2. If not already on, power-up the PC that has RPM and the Key Loader applications installed on it, and start Windows®.
3. Connect the radio to the PC using a serial cable (CA-023407-003).
4. Enter into the Harris Keyload Mode (HKL).
  - a. Press the radio's **M** button.

- b. Scroll through the menu to select the **KEYLOAD** option and press the  button to activate.
  - c. Scroll through and select the **HKL** option and press the  button. The radio can now accept keys from the Keyloader.
5. Load the UKEK file from the Crypto Officer onto the PC.
6. Run the RPM application and setup the radio's Personality according the SLN Binding Report information.
7. Setup the talk groups and the SLN mappings (Talk Group ID to SLN). This includes mapping SLNs to the "System" keys (PSTN, All Call, etc.).
8. Select **Options → P25 OTAR Options** and set the following:
  - a. The OTAR Message Number Period (MNP) as defined by the System Administrator.
  - b. The radio's Individual RSI (from the SLN Bindings Report).
  - c. The KMF's RSI (from the SLN Bindings Report).
9. Program the Personality to the radio.
10. Run the Key Loader application.
11. Open the UKEK file loaded in step 5.
12. Select the Target Device type and click the **Load** button.
13. The Key Loader reads the target device's identifying information, retrieves a UKEK of the proper algorithm type from the UKEK file, and downloads the UKEK to the target device at the proper SLN and keyset with the proper key ID.
14. Click the **Finish** button to exit the Key Loader application. New UKEKs have are loaded and the radio is now ready to accept TEKs via OTAR with the trunked radio network.

#### **A.1.2.2 Load Keys Using Key Loader**

Key Loader is part of Key Manager and can be used by the Crypto Officer or Technician to load the keys into the radio.

Refer to the Key Loader online help if additional information is required when performing this procedure.

1. Connect the radio to the PC using a serial cable.
2. Power on the radio, if not already.
3. Select **Start → Programs → Harris Key Manager → Harris Key Loader**.
4. At the Key Loader Welcome screen, click **Next**.
5. Select **Load a Distribution Set into one or more devices**.
6. Click **Next**.
7. Browse to the Key File and enter the password.
8. Click **Next** to validate the password and continue. If the password is incorrect, the screen will display an error message.
9. Select communication port from the drop-down and click **Next**.

10. Select the serial port that you have connected to the radio.
11. Enter into Harris Keyload Mode (HKL).
  - a. Press the radio's  button.
  - b. Scroll through the menu to select the **KEYLOAD** option and press the  button to activate.
  - c. Scroll through and select the **HKL** option and press the  button. The radio can now accept keys from the Keyloader.
12. Select **Radio** from the drop-down and click **Load**.
13. Click **Finish**.

#### A.1.2.3 Power on the Motorola KVL Device

1. Connect KVL Device to the radio using cable 14002-0143-01.



Once the KVL Device is connected, a keyset is established whether the keys are loaded or not. You will need to zeroize to bring the radio to a fully zeroized state.

2. Press the radio's  button.
3. Scroll through the menu to select the **KEYLOAD** option and press the  button to activate.
4. Scroll through and select the **KVL** option and press the  button. The radio can now accept keys from the KVL Device.

#### A.1.2.4 Load Keys Using Motorola KVL Device

Type 3 Digital Encryption Standard Output Feedback (DES-OFB) and Advanced Encryption Standard, 256-bit (AES-256), encryption methods are supported. The Type 3 Encryption keys are loaded via a Motorola Device using Telecommunications Industry Association (TIA)/Project 25 (P25) key fill device protocol. Make sure that valid keys have been created and stored in the KVL Device before proceeding.

#### A.1.3 Protected Keys

The Protected Keys feature transfers P25 Voice Keys, from Key Loader to the radio, that have been wrapped (AES) or encrypted (DES) with Key Protection Keys (KPKs). KPKs are nothing more than unprotected Key Encryption Keys (KEKs). The KPKs need to be loaded into the radio before the Protected Keys are loaded. Once loaded into the radio, the KPKs will be used to unwrap (AES) or decrypt (DES) the Protected Keys.

The radio must be placed into the key loading mode (see Section A.1.2.2) in order to accept the KPKs and P25 Voice Keys.

**NOTES**

**About L3Harris Technologies**

L3Harris Technologies is an agile global aerospace and defense technology innovator, delivering end-to-end solutions that meet customers' mission-critical needs. The company provides advanced defense and commercial technologies across air, land, sea, space and cyber domains.